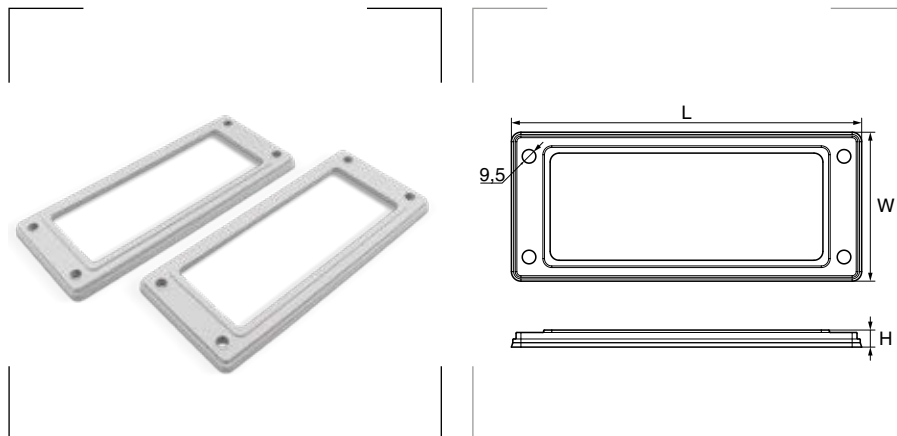

Marcos pasamuros Design-A FL21 configurables

Grado de protección

Polvo/agua: IP65.

Materiales

 Termoplástico TPE y polipropileno.
 Elastómero reforzado con fibra de vidrio.

Colores

Gris claro

RAL 7035

Negro

RAL 9005

Certificados y normas aplicables

Norma EN 60529:1991+A1

Norma EN 60670-1:2005

Aprobación UL

Certificación SEMKO 816003



Temperatura de trabajo

-20°C a +125°C (sin tensión).











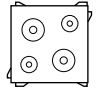

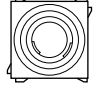

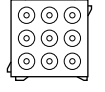

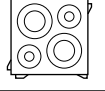
Descripción

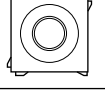
 El marco pasamuros **Design-A** es un sistema **modular**. Elija las **membranas push-out** que desee instalar en el marco **FL21** vacío.

Marco vacío FL21

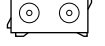
Referencia Gris	Referencia Negro	Esquema	Modelo	L mm	W mm	H mm	Embalaje unidades
T2665400	T2665418			214	90	9	10

Placas de inserción para marco FL21

Referencia Gris	Referencia Negro	Esquema	Modelo	Medidas ancho x alto en mm	Orificios mm	Cable Ø mm	Embalaje unidades
T2665406	T2665424			68 x 68	2 x M25 2 x M16	8 - 17 5 - 10	10
T2665407	T2665425			68 x 68	1 x M50,	-	10
T2665408	T2665426			68 x 68	9 x 7-14	7 - 14	10
T2665409	T2665427			68 x 68	2 x 20-30	20 - 30 10 - 20	10
T2665410	T2665428			68 x 68	30-50	30 - 50	10
T2665411	T2665429			68 x 34	2 x 8-17	8 - 17	10
T2665412	T2665430			68 x 34	2 x M20	6 - 13	10
T2665413	T2665431			68 x 34	10 x 4-10	4 - 10	10