

Marcos pasamuros Design-A FL13 configurables

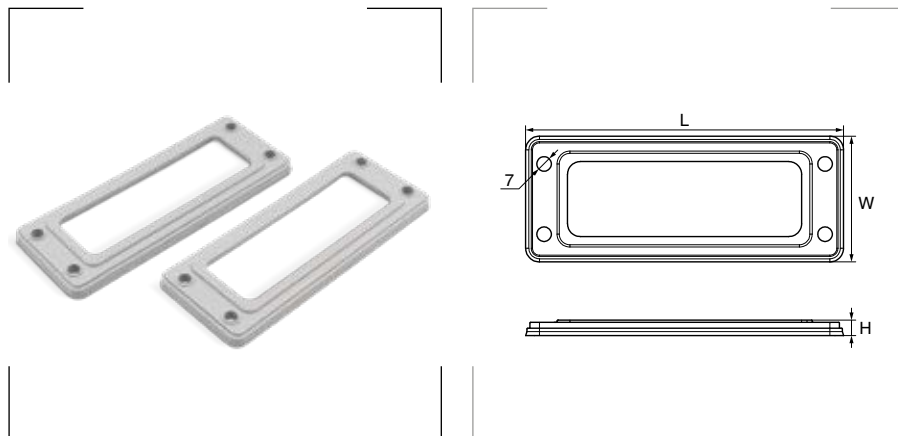

Grado de protección

Polvo/agua: IP65.

Materiales

Termoplástico TPE y polipropileno.
Elastómero reforzado con fibra de vidrio.

Colores

Gris claro

RAL 7035 

Negro

RAL 9005 

Certificados y normas aplicables



Norma EN 60529:1991+A1

Norma EN 60670-1:2005

Aprobación UL

Certificación SEMKO 816003



Temperatura de trabajo

-20°C a +125°C (sin tensión).





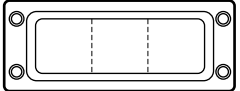



Descripción

El marco pasamuros **Design-A** es un sistema **modular**. Elija las **membranas push-out** que desee instalar en el marco **FL13** vacío.

Marco vacío FL13

Referencia Gris	Referencia Negro	Esquema	Modelo	L mm	W mm	H mm	Emb. uds.
T2665404	T2665422			134	52	6,5	10

Placas de inserción para marco FL13

Referencia Gris	Referencia Negro	Esquema	Modelo	Medidas ancho x alto en mm	Orificios mm	Cable Ø mm	Embalaje unidades
T2665414	T2665432			34 x 68	2 x 8-17	8 - 17	10
T2665415	T2665433			34 x 68	2 x M20	6 - 13	10
T2665416	T2665434			34 x 68	10 x 4-10	4 - 10	10
T2665417	T2665435			34 x 34	1 x M20	6 - 13	10