

Bases empotrables rectas hembra - SERIE PE ... PQ

PE 1674 PQ

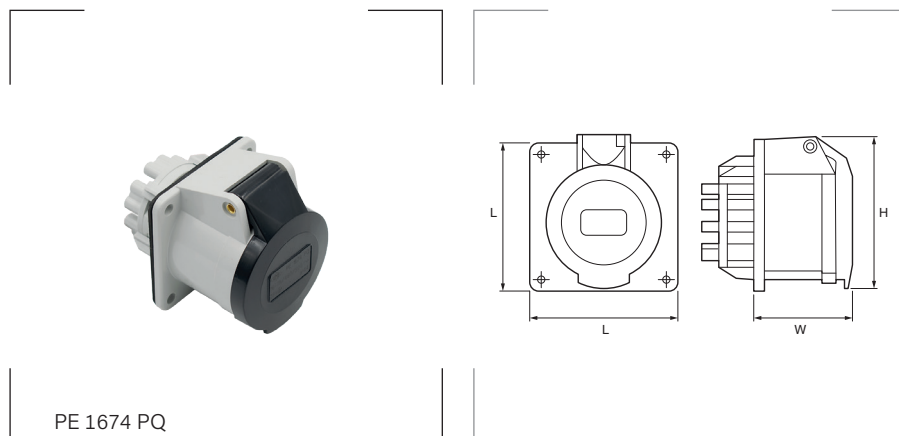



Grado de protección

Polvo/agua: IP44.

Materiales

Cuerpo, bloque y tapa en material aislante termoplástico autoextinguible.

Colores

Gris claro	RAL 7035	
Amarillo	RAL 1021	
Azul	RAL 5015	
Rojo	RAL 3000	
Negro	RAL 9005	

Certificados y normas aplicables





EN 60309-1 y 60309-2.

Temperatura de trabajo

-25°C hasta +40°C.

Descripción

Tapa con muelle. Brida completa con junta antienviejimiento.

Referencia	Tensión V	Corriente A	Polos	Referen. horaria	L mm	W mm	H mm	Emb. uds.
PE 1643 PQ		16	2P + ⊕	4h	65	52	71	10
PE 1644 PQ			3P + ⊕	4h	65	53	75	10
PE 1645 PQ			3P + N + ⊕	4h	80	53	86	10
PE 3243 PQ	100 ÷ 130 V	32	2P + ⊕	4h	80	62	87	10
PE 3244 PQ			3P + ⊕	4h	80	62	87	10
PE 3245 PQ			3P + N + ⊕	4h	80	62	92	10
PE 1663 PQ		16	2P + ⊕	6h*	65	52	71	10
PE 1694 PQ			3P + ⊕	9h	65	53	75	10
PE 1695 PQ			3P + N + ⊕	9h	80	53	86	10
PE 3263 PQ	200 ÷ 250 V	32	2P + ⊕	6h*	80	62	87	10
PE 3294 PQ			3P + ⊕	9h	80	62	87	10
PE 3295 PQ			3P + N + ⊕	9h	80	62	92	10
PE 1693 PQ		16	2P + ⊕	9h	65	52	71	10
PE 1664 PQ			3P + ⊕	6h*	65	53	75	10
PE 1665 PQ			3P + N + ⊕	6h*	80	53	86	10
PE 3293 PQ	380 ÷ 415 V	32	2P + ⊕	9h	80	62	87	10
PE 3264 PQ			3P + ⊕	6h*	80	62	87	10
PE 3265 PQ			3P + N + ⊕	6h*	80	62	92	10
PE 1674 PQ		16	3P + ⊕	7h	65	52	71	10
PE1675 PQ			3P + N + ⊕	7h	65	53	75	10
PE 3274 PQ		480 ÷ 500 V	32	3P + ⊕	7h	80	62	87
PE 3275 PQ	3P + N + ⊕			7h	80	62	92	10

* Los artículos con posición horaria 6h se refieren a la tensión más habitual (2P+⊕/220 ÷ 250V ~ - 3P+⊕ y 3+N+⊕/380÷415V).