



4G LTE Mobile Wi-Fi User Guide

V1.0

Copyright Statement

© 2022 Shenzhen Tenda Technology Co., Ltd. All rights reserved.

Tenda is a registered trademark legally held by Shenzhen Tenda Technology Co., Ltd. Other brand and product names mentioned herein are trademarks or registered trademarks of their respective holders. Copyright of the whole product as integration, including its accessories and software, belongs to Shenzhen Tenda Technology Co., Ltd. No part of this publication can be reproduced, transmitted, transcribed, stored in a retrieval system, or translated into any language in any form or by any means without the prior written permission of Shenzhen Tenda Technology Co., Ltd.

Disclaimer

Pictures, images and product specifications herein are for references only. To improve internal design, operational function, and/or reliability, Tenda reserves the right to make changes to the products without obligation to notify any person or organization of such revisions or changes. Tenda does not assume any liability that may occur due to the use or application of the product described herein. Every effort has been made in the preparation of this document to ensure accuracy of the contents, but all statements, information and recommendations in this document do not constitute the warranty of any kind, express or implied.

Preface

Thank you for choosing Tenda! Please read this user guide before you start.

This user guide is applicable to 4G LTE Mobile Wi-Fi (4G180 and 4G185). Both “Mobile Wi-Fi” and “Hotspot” mentioned in this guide refer to 4G LTE Mobile Wi-Fi.



The appearance and functions of 4G180 and 4G185 may differ. Please refer to the actual product. The web UI screenshots in this guide are mostly taken from 4G185 for illustration if there is no other specification.

Conventions

The typographical elements that may be found in this document are defined as follows.

Item	Presentation	Example
Cascading menus	>	SMS > Device SMS
Parameter and value	Bold	Set Mode to USB .
Variable	Italic	Format: <i>XX:XX:XX:XX:XX:XX</i>
UI control	Bold	On the Policy page, click the OK button.
Message	“ ”	The “Success” message appears.

The symbols that may be found in this document are defined as follows.

Symbol	Meaning
 NOTE	This format is used to highlight information of importance or special interest. Ignoring this type of note may result in ineffective configurations, loss of data or damage to device.
 TIP	This format is used to highlight a procedure that will save time or resources.

For more documents

If you want to get more documents of the device, visit www.tendacn.com and search for the corresponding product model.

The related documents are listed as below.

Document	Description
Data Sheet	It introduces the basic information of the device, including product overview, selling points, and specifications.
Quick Installation Guide	It introduces how to set up the device quickly for internet access, the descriptions of LED indicators, ports, and buttons, FAQ, statement information, and so on.
User Guide	It introduces how to set up functions of the device for more requirements, including all functions on the web UI of the device.

Technical Support

If you need more help, contact us by any of the following means. We will be glad to assist you as soon as possible.



Hotline

Global: (86) 755-27657180

(China Time Zone)

United States: 1-800-570-5892

(Toll Free: 7 x 24 hours)

Canada: 1-888-998-8966

(Toll Free: Mon - Fri 9 am - 6 pm
PST)

Hong Kong: 00852-81931998



Email

support@tenda.com.cn



Website

<https://www.tendacn.com/>

Revision History

Tenda is constantly searching for ways to improve its products and documentation. The following table indicates any changes that might have been made since the user guide was released.

Version	Date	Description
V1.0	2022-03-24	Original publication

Contents

1	Get to Know Your Device	1
	1.1 Overview	1
	1.2 Buttons, slots and port	1
	1.3 Screen.....	3
	1.3.1 Screen of 4G180	3
	1.3.2 Screen of 4G185	4
	1.4 Label.....	5
2	Set up Internet Connection	7
	2.1 Connect the hotspot to the internet	7
	2.2 Connect clients to the hotspot	9
	2.2.1 Connect a client to the hotspot in a wired manner	9
	2.2.2 Connect a client to the hotspot in a wireless manner	10
3	Web Login and Logout.....	14
	3.1 Log in to the web UI	14
	3.2 Log out of the web UI	15
	3.3 Web UI layout.....	16
4	Quick Settings.....	17
5	Home Page	19
	5.1 Connect status.....	20
	5.2 Network settings	21
	5.2.1 Connection mode	21
	5.2.2 Network selection	22
	5.2.3 APN.....	23
	5.3 Wi-Fi settings.....	25

5.3.1	Main SSID	25
5.3.2	Guest SSID	27
5.3.3	WPS	28
5.3.4	Internet Wi-Fi	29
5.3.5	Advanced settings.....	33
5.3.6	WLAN MAC filter	34
5.4	Connected devices	36
5.5	Data management	38
5.6	Status information.....	40
6	SMS	42
6.1	Device SMS.....	42
6.2	SIM SMS	46
6.3	SMS settings	47
7	USSD.....	48
8	Advanced Settings	49
8.1	Power-save	49
8.2	Router.....	51
8.3	Firewall.....	53
8.3.1	Port filtering	54
8.3.2	Port mapping.....	57
8.3.3	Port forwarding.....	59
8.3.4	UPnP	62
8.3.5	DMZ.....	62
8.4	Update.....	64
8.5	SD card and HTTP share.....	65
8.5.1	SD card	65
8.5.2	HTTP share.....	68
8.6	Others.....	72

8.6.1 Restart and reset	72
8.6.2 Turn off device.....	72
8.6.3 Fast boot settings	73
8.6.4 SNTP	73
8.6.5 PIN management.....	74
Appendix.....	77
A.1 FAQ.....	77
A.2 Set the IP address of your computer (Example: Windows 7).....	79
A.3 Acronyms and Abbreviations	81

1 Get to Know Your Device

1.1 Overview

4G180 and 4G185 are designed as your reliable personal Wi-Fi hotspots.

Just inserting a SIM card, you can enjoy fast 4G LTE network with your family and friends.

Besides, you can prepare an SD card (32 GB or less) for file storage and file share.

Compact body with a large-capacity battery, the mobile Wi-Fi offers easy networking wherever you go. When the power is low, you can charge the battery with a micro USB cable connected to power supply devices such as a power adapter, laptop or portable charger. Even without a battery, when the 4G180 and 4G185 are connected to such power supply devices with a micro USB cable, they can still be powered on for network connection.

Along with the basic operations achieved through the buttons and port, the devices also allow you to configure more functions on the web UI.

1.2 Buttons, slots and port

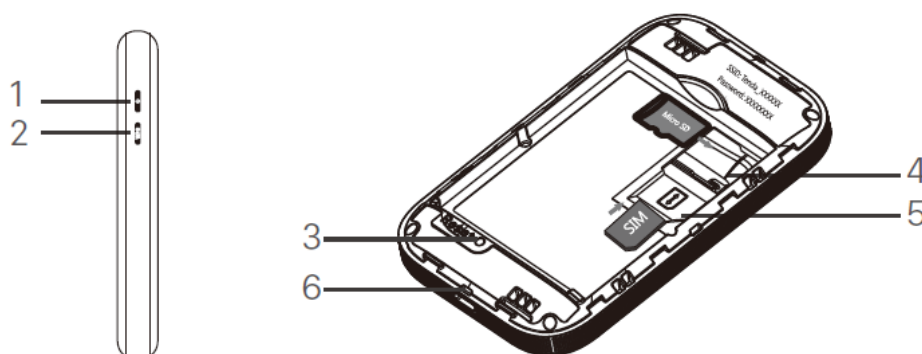





No.	Button/Port/Slot	Description
1		Power button. <ul style="list-style-type: none"> • Hold it for about 3 seconds to turn on/off the Hotspot.

No.	Button/Port/Slot	Description
		<ul style="list-style-type: none"> • Press it once to turn on its LED indicators/LCD screen. <p> TIP</p> <p>When the LCD screen of 4G185 is on, press it once to show the SSID and Wi-Fi key. Press it twice to show a QR code of the Wi-Fi information.</p>
2	WPS	<p>WPS button.</p> <p>When the WPS function is enabled:</p> <ul style="list-style-type: none"> • 4G180: The Wi-Fi LED indicator blinks. • 4G185: WPS Active is shown on the LCD screen. <p>Hold the button down for about 3 seconds to enable the WPS function. Besides, you need to enable the WPS function on a WPS-supported device to establish a WPS negotiation.</p>
3	Reset	<p>Reset button.</p> <p>Hold the button using a sharp object for about 6 seconds, and then release it when all LED indicators light up once and then light off. When the LED indicators light again, the Hotspot is restored to factory settings successfully.</p>
4	SD card slot	Insert your SD card here to increase storage space.
5	SIM card slot	Insert your SIM card here.
6	Charging/Micro USB port	Used to charge the Hotspot, or to provide internet access for wired devices using the USB cable.

1.3 Screen







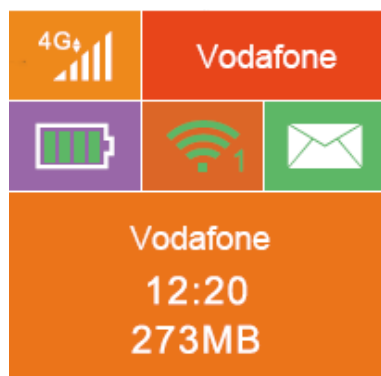

1.3.1 Screen of 4G180



LED	Status	Description
 (Signal)	Solid green	Connected to the internet.
	Blinking green	Signal detected, but no internet access.
	Solid red	No signal.
 (Battery)	Solid green	Remaining battery is above 25%.
	Blinking green	Charging the battery.
	Solid red	Remaining battery is between 20% and 25%.
	Blinking red	Remaining battery is below 20%.
 (Message)	Blinking green for 5 times	A new SMS message is received or the storage is full.
	Solid green	There are unread SMS messages.
	Off	No unread SMS messages.
 (Wi-Fi)	Solid on	No device is connected to the Wi-Fi network.
	Blinking	There is at least one device connected to the Wi-Fi network, or a WPS negotiation is in process.
	Off	The Wi-Fi network is disabled.

1.3.2 Screen of 4G185

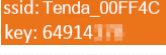

Item	Description
	It displays the 3G/4G network type and signal strength.
	It displays the network carrier name.
	It displays the remaining battery power.
	It displays the Wi-Fi status and the number of connected Wi-Fi clients.
	If there are unread SMS messages, a red dot appears on this icon.
	It displays the name of the carrier, the system uptime, and the data usage after device startup.
	It displays the Wi-Fi name and password of the device.
	It displays the QR code for connecting a client to the Wi-Fi network of the device. To set up a connection in this way, scan the QR code using the Wi-Fi scan function of your mobile phone (as an example).

1.4 Label

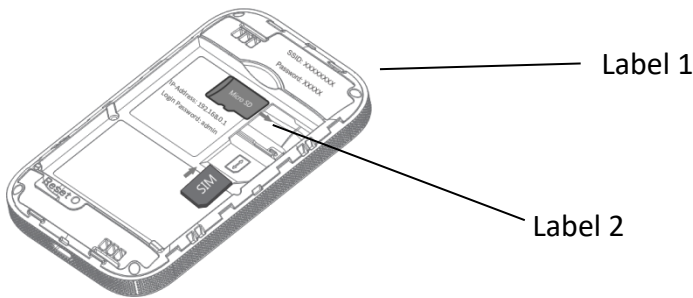

Label 1:

Item	Description
SSID: Tenda_XXXXXX	It displays the default Wi-Fi name and Wi-Fi password of the device.
Wi-Fi KEY: XXXXXXXX	You can find the SSID and enter the Wi-Fi key to connect a client to the device.

Label 2:

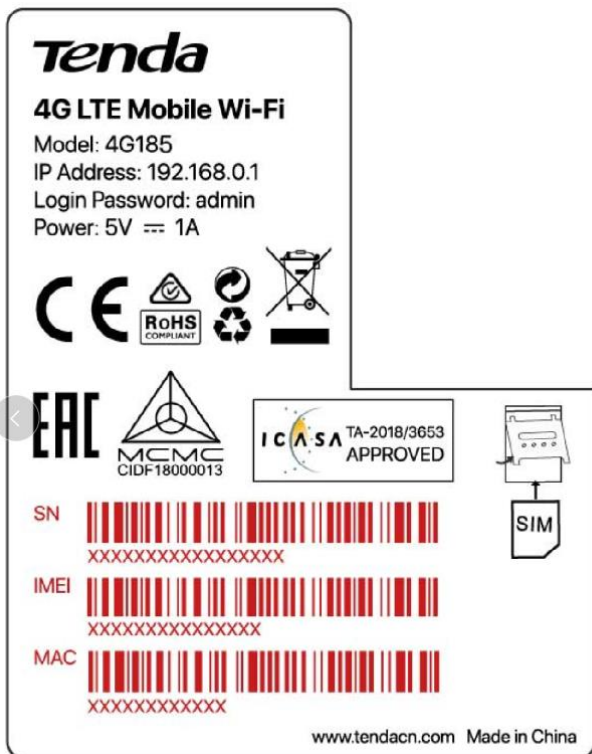

Item	Description
Model	It displays the model name of the device.

Item	Description
IP Address	It displays the default IP address of the device. You can use it to log in to the web UI of the device.
Login Password	It displays the default login password of the web UI. Enter the default login password upon first usage or after the hotspot is restored to factory settings. You can modify the login password at the upper-right corner of the web UI.
Power	It displays the rated power of the device.
SN	It displays the SN number used for product identification.
IMEI	It displays the International Mobile Equipment Identity (IMEI) usually used to identify valid mobile phones in the network.
MAC	It displays the physical address of the device.

2 Set up Internet Connection

2.1 Connect the hotspot to the internet

To connect the hotspot to the internet, perform the following steps:

Step 1 Open from the lower left corner to remove the back cover.

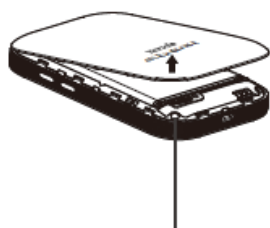

Step 2 Slide and lift up the slot cover, insert a 3FF SIM card (an LTE, UMTS, or WCDMA SIM card) into the SIM card slot, and slide the cover back to lock.



If a Nano SIM card (4FF) is used, use the included SIM card adapter to convert it into a 3FF SIM card.

Ensure that the SIM card has sufficient balance and can be used to access the data service of your mobile carrier.

Step 3 Insert an SD card (if any), with the same operation above.



Slide and flip to open



Ensure the pins of the card contact the pins of the slot properly.

Step 4 Install the battery.



Without battery installed, the hotspot can also be powered on for network connection, as long as you use a micro USB cable to connect the hotspot to devices such as a power adapter, laptop or portable charger for power supply.

Step 5 Restore the back cover.

Step 6 Hold the Power button till all LED indicators flash once (4G180) or the LCD screen lights up (4G185) to turn on the hotspot.

---End

The device is connected to the internet, when

- the signal strength icon lights solid green (4G180).
- the signal strength icon, network type icon and carrier information appear on the screen (4G185).

2.2 Connect clients to the hotspot

You can connect clients to the hotspot in a wired or wireless manner so that the clients can access the internet through the hotspot.

2.2.1 Connect a client to the hotspot in a wired manner

Step 1 Use the included USB cable to connect the hotspot to a USB port of the client (Here takes a Windows computer as an example).

Step 2 Double-click the folder **CD Drive (G:) 4G Mobile** and follow instructions to install the driver.

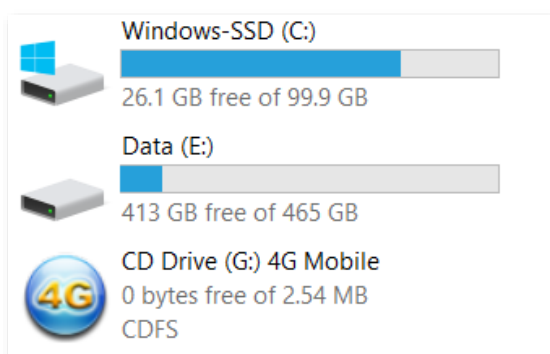

---End

The driver is installed successfully when the following page appears.

After the wired client is connected to the hotspot, you can access the internet through the hotspot.

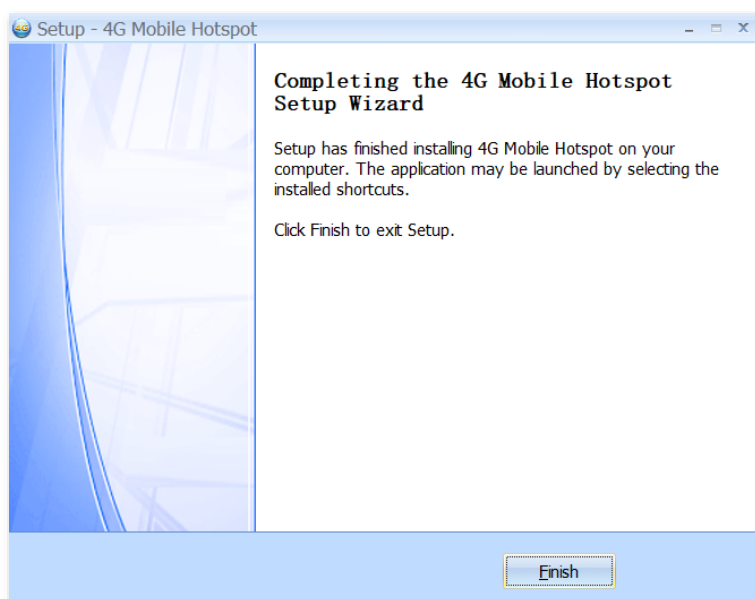

2.2.2 Connect a client to the hotspot in a wireless manner

Method One: Using the SSID and Wi-Fi Key



To connect a PC to the hotspot in a wireless manner, install a wireless network adapter on the PC.

Step 1 Note down the default SSID (Wi-Fi name) and Wi-Fi key (Wi-Fi password) on the label after opening the back cover.

Step 2 Select the Wi-Fi name of the hotspot on your client, and enter the password.



If you have changed the default SSID and key, view them on the web UI.

(For 4G185, when the screen is on, you can press the Power button once to show the current SSID and key.)

---End

Method Two: Scanning the QR code

The Wi-Fi information QR code is shown on the web UI of the hotspot (for both 4G180 and 4G185) or on the LCD screen (only for 4G185).

You can scan the QR code to connect your own client to the hotspot or take a picture of the QR code to share the hotspot with your family or friends.

For 4G185

Step 1 When the 4G185's LCD screen is on, press the Power button twice to show the QR code.

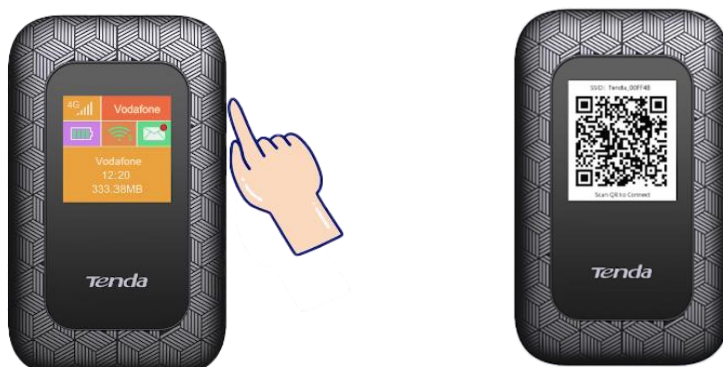

Step 2 Scan the QR code using the Wi-Fi scan function of your mobile phone to connect to the wireless network of the hotspot.



iOS 12.1/Android 9 or newer version are supported.

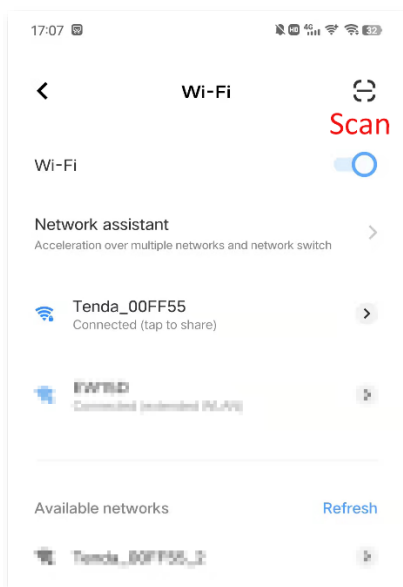

Your mobile phone will be automatically connected to the Wi-Fi without any settings.

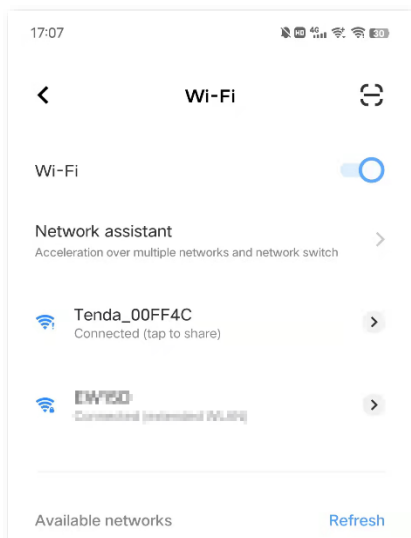

---End

For both 4G180 and 4G185

Step 1 Use the included USB cable to connect the hotspot to a USB port of a computer, and download the **4G Mobile** driver just as in section [2.2.1](#).

Step 2 Start a web browser on the computer, and visit **192.168.0.1**.

Step 3 Enter password (**admin** by default) and click **Login**.

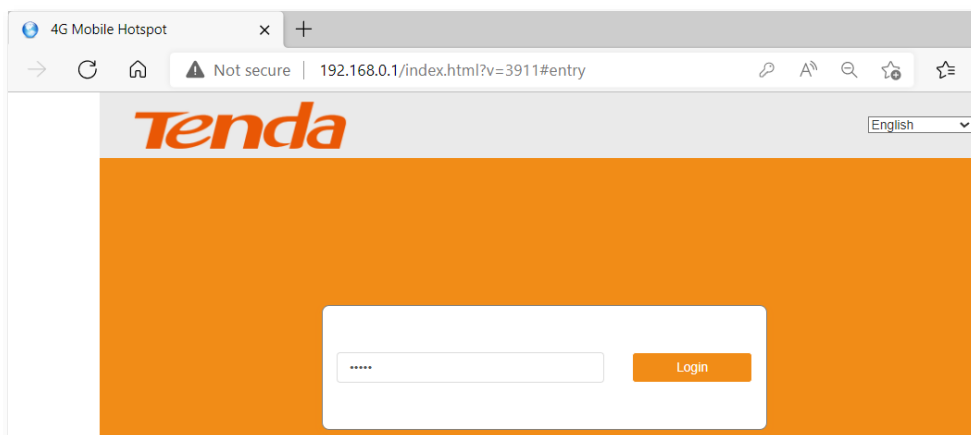

Step 4 Choose **Wi-Fi Settings > Main SSID**, the QR code appears.

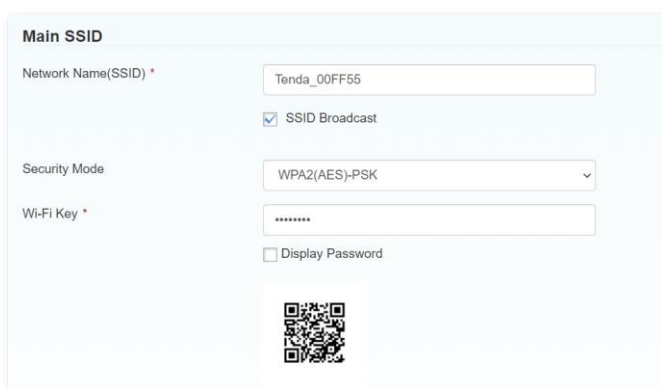
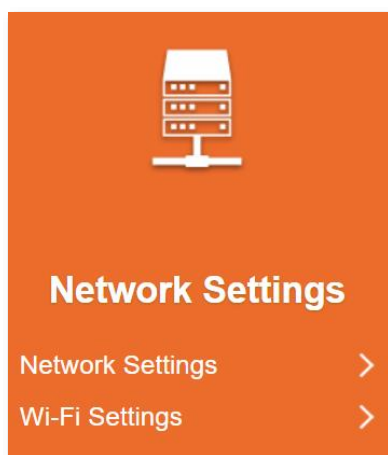

Step 5 Scan the QR code using the Wi-Fi scan function of your mobile phone to connect to the wireless network of the hotspot;
or, take a picture of the QR code to share the hotspot with your family or friends.

---End

Method Three: Using WPS (Wi-Fi Protected Setup)

WPS allows you to connect a client to the hotspot in a wireless manner without the Wi-Fi name or password of the hotspot.

Step 1 Hold down the WPS button for 3 seconds to enable the WPS function of the hotspot.

Step 2 Enable the WPS function on the client within 2 minutes.

Step 3 Wait for the client to automatically connect to the hotspot.

---End

3 Web Login and Logout

3.1 Log in to the web UI

After a client (such as a smartphone or a computer) is connected to the hotspot, you can start a web browser on the client to log in to the web UI (default IP address: 192.168.0.1) of the hotspot.

Step 1 Connect the client to the hotspot.

For details about how to connect the client to the hotspot, see [2.2 Connect clients to the hotspot](#).

Step 2 Start a web browser on the client, and visit **192.168.0.1**.

Step 3 Enter password (**admin** by default) and click **Login**.

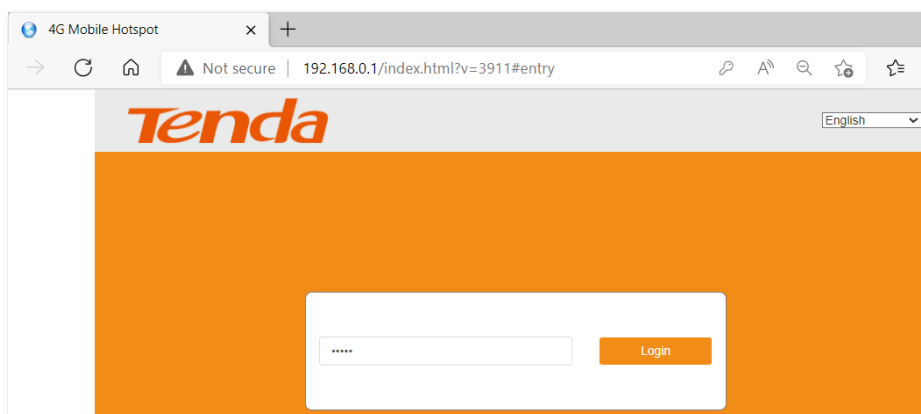

NOTE

If this page is not displayed, refer to [Q1](#) in Appendix A.1 FAQ.

---End

3.2 Log out of the web UI

If you perform no operation on the web UI or no wireless client is communicating with the device within the specified **Wi-Fi Sleep** Time (configured at [Advanced Settings > Power-save](#)), the system logs you out.

You can log out by clicking **Logout** on the upper right corner of the web UI as well.

When you are logged out, the system does not save the current unsaved configurations. Therefore, it is recommended that you save the current configuration before logging out.

3.3 Web UI layout

The web UI consists of three sections, including the level-1 and level-2 navigation bars, and the configuration area. See the following figure.

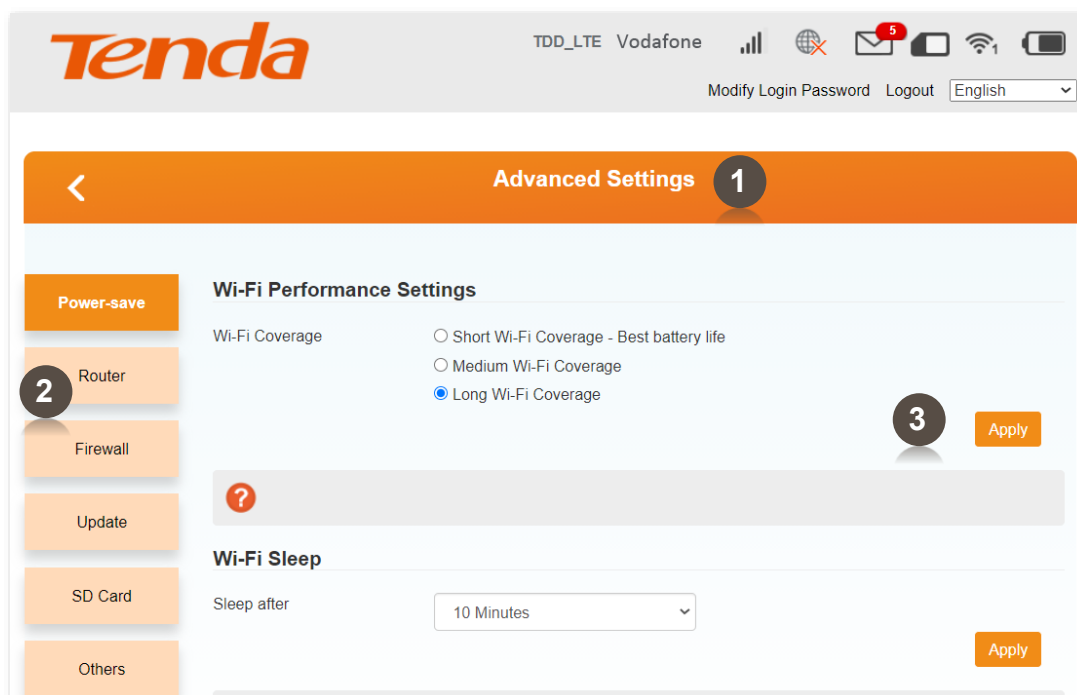

No.	Name	Description
1	Level-1 navigation bar	They are used to display the function menu of the device. Users can select functions in the navigation bars and the configuration appears in the configuration area.
2	Level-2 navigation bar	
3	Configuration area	It is used to view or modify your configuration.

NOTE

The functions and parameters dimmed on the web UI are not supported by the hotspot or cannot be changed in the current configuration.

4 Quick Settings

Before moving on to other configurations, you need to configure the internet settings of the hotspot.

To quickly configure the settings, perform the following steps:

Step 1 Start a web browser on the client, and visit **192.168.0.1** to log in to the web UI.

Step 2 Choose **Quick Settings**.

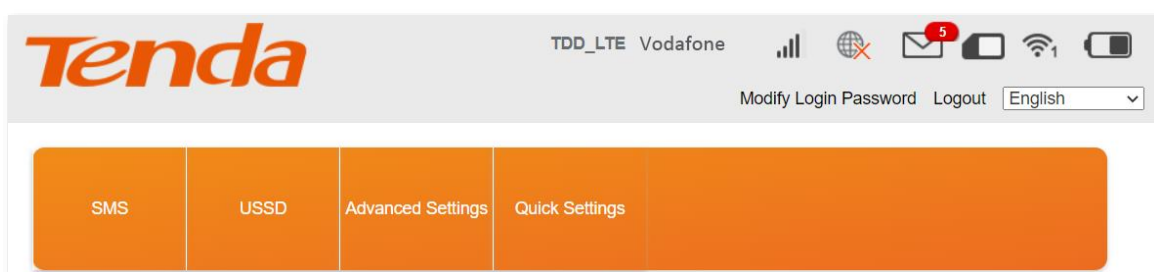

Step 3 Choose to configure APN settings automatically or manually, and click **Next**.

You can manually select an APN only after adding it and setting it as the default APN on the **Network Settings > APN** page. In this example, **Auto** is selected.

Step 4 Set **Network Name (SSID)** to a required Wi-Fi name, set **SSID Broadcast** to specify whether to broadcast the Wi-Fi name, and click **Next**.

 A screenshot of the SSID configuration page in the Tenda web UI. At the top right are 'Previous' and 'Next' buttons. The page title is 'SSID'. There is a text input field for 'Network Name(SSID) *' containing the text 'Tenda_00FF4C'. Below it is a radio button selection for 'SSID Broadcast' with 'Enable' selected and 'Disable' unselected. At the bottom left, there is a red question mark icon in a circle.

Step 5 Select a security mode from the **Security Mode** drop-down list box, set **Wi-Fi Key** to the password of the Wi-Fi network, and click **Next**.

[Previous](#) [Next](#)

Security Mode

Security Mode

Wi-Fi Key *

Display Password





TIP

The password is invisible by default. To view the password, select **Display Password**.

Step 6 Verify the settings and click **Apply**.

[Previous](#) [Apply](#)

Configuration as Follows

APN Settings	Auto
Network Name(SSID)	Tenda_00FF4C
SSID Broadcast	Enable
Security Mode	WPA2(AES)-PSK

---End

5 Home Page

On the home page, you can view or set the following parameters and functions:

- [Connect status](#)
- [Network settings](#)
- [Wi-Fi settings](#)
- [Connected devices](#)
- [Data management](#)
- [Status information](#)

5.1 Connect status

Here, you can click the **ON/OFF** button to connect the hotspot to or disconnect the hotspot from the internet.

When the hotspot is connected to the internet, it displays the upload data, download data and the connection time. See the following figure.

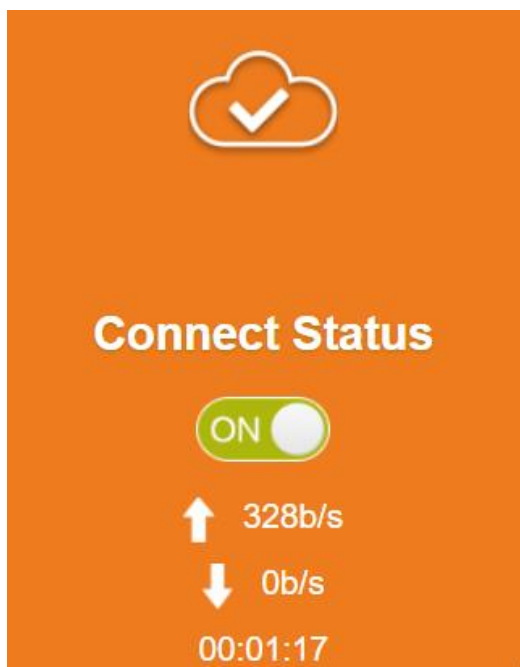

5.2 Network settings

This module enables you to configure the connection mode, select the mobile network to connect, and set APN profiles.

5.2.1 Connection mode

Here, you can specify whether the device connects to the internet automatically after it is powered on.

Navigate to **Network Settings > Connection Mode** to enter the page.



TIP

To change the current setting, please disconnect from network.

- To enable the hotspot to connect to the internet automatically after it is powered on, select **Automatic**, and click **Apply**.

The “**Success**” message appears, and the hotspot is connected to the internet.



TIP

If you want the hotspot to automatically connect to the internet when it is in roaming status, select **Check here, you can connect to internet in the roaming status**.

- To disable the hotspot to connect to the internet automatically after it is powered on, select **Manual**, and click **Apply**.

The “**Success**” message appears, and the hotspot is disconnected from the internet.



After adopting the **Manual** option, you have to connect the device to the internet manually on the **Home** page.

5.2.2 Network selection

This mobile Wi-Fi supports network selection modes of **Automatic**, **4G Only**, **3G Only**, and **Manual**.

Navigate to **Network Settings** > **Network Selection** to enter the page.



To change the current setting, please disconnect from network.

If your SIM card supports WCDMA, you can select **3G Only**.

If your SIM card supports FDD-LTE or TDD-LTE, you can select **4G Only**.

If you are not clear about that, **Automatic** is recommended. The hotspot will automatically establish internet connection when it is started.

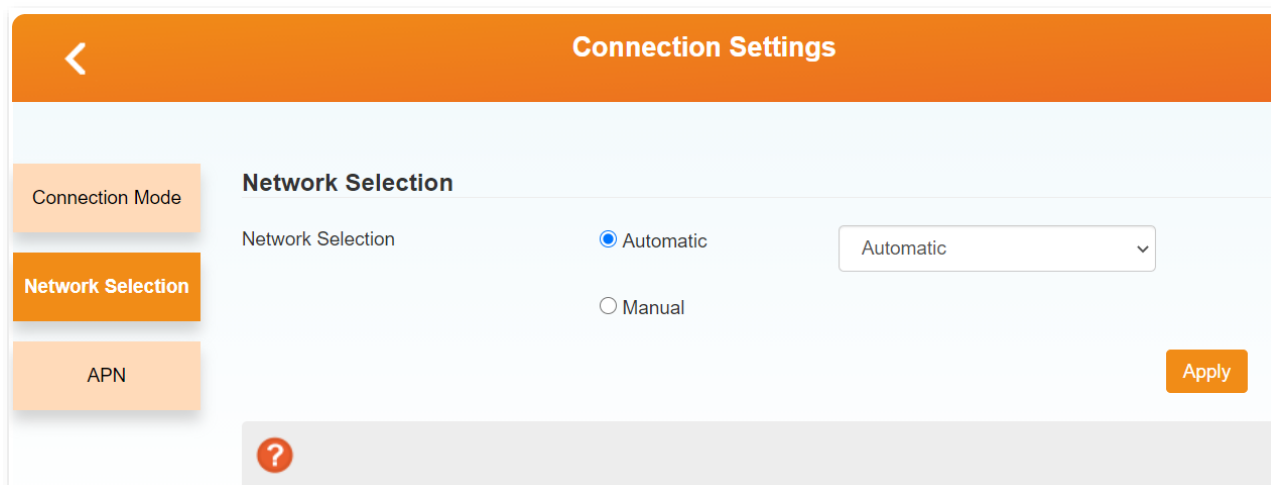

If you want to manually select a mobile network, select **Manual**, click **Search**, select an available mobile network from the network list, and click **Register**.

Network List					
Option	Status	Operator	MCCMNC	Network Type	Act
<input checked="" type="radio"/>	Current	Vodafone	22210	4G	FDD-LTE
<input type="radio"/>	Forbidden	UNICOM	46001	4G	FDD-LTE
<input type="radio"/>	Available	CT	46011	4G	FDD-LTE

[Register](#)

5.2.3 APN

An APN (Access Point Name) is a gateway between a cellular network and the internet. A mobile device making a data connection must be configured with an APN to present to the network carrier.

When the device already received 4G signal but cannot be connected to the internet properly, in this case, you need to configure the APN dial-up information of the carrier. The APN information can be obtained by consulting the carrier's service personnel.

Navigate to **Network Settings > APN** to enter the page.

APN

Current APN: Vodafone Italy

Mode: Auto Manual

Profile:

PDP Type:

Profile Name *:

APN *:

Authentication:

User Name:

Password:

Dial No.: *99#

Parameter	Description
Current APN	It specifies the currently used APN.

Parameter	Description
Mode	<p>It specifies whether to select an APN automatically or manually.</p> <p>If your ISP provides APN settings, select Manual; otherwise, select Auto.</p> <p> NOTE</p> <p>If you switch from one mode to the other, the device is disconnected from the internet and you must manually reconnect it to the internet.</p>
Profile	It specifies the profile (ISP) of the current APN.
Profile Name	It specifies the name of the profile. You can click Add New and add another profile as required.
PDP Type	It specifies the Packet Data Protocol (PDP) type of the APN, including IPv4, IPv6, and IPv4v6.
APN	It specifies the Access Point Name. Only digits, uppercase and lowercase letters, dots (.), and hyphens (-) are allowed in an APN name. An APN name cannot start with or end with a dot or hyphen.
Authentication	<p>It specifies the authentication mode specified by your ISP for the APN.</p> <ul style="list-style-type: none"> • PAP: Password Authentication Protocol (PAP) provides a simple method without encryption for the peer to establish its identity using a 2-way handshake. • CHAP: Challenge-Handshake Authentication Protocol (CHAP) is used to periodically verify the identity of the peer using a 3-way handshake.
User Name	It specifies the user name for authentication.
Password	It specifies the password for authentication.
Dial No.	It specifies the dial-up number for mobile networking.

You can select one profile and set the corresponding parameters.

If you need to add a new APN profile, perform the following steps:

- Step 1** Choose **Network Settings > APN**.
- Step 2** Select **Manual** and click **Add New**.
- Step 3** Set the corresponding parameters based on the APN information provided by your ISP.
- Step 4** Click **Apply**.

---End

After adding or selecting an APN profile, click **Set as default** to set the profile as the default one. APN profile is available for manual configuration during quick settings only after being set as a default APN.

5.3 Wi-Fi settings

Before more Wi-Fi settings, you can enable or disable the **Wi-Fi Switch** and **Multi SSID Switch** first.

Wi-Fi Switch: It is used to enable or disable the wireless hotspot.

Multi SSID Switch: It is used to enable or disable a guest SSID besides the main SSID.

5.3.1 Main SSID

Here, you can set parameters of the **Main SSID**.

Click **Wi-Fi Settings > Main SSID** to enter the page.

Main SSID

Network Name(SSID) *

SSID Broadcast

Security Mode ▾

Wi-Fi Key *

Display Password



Show On Lcd Yes No

Max Station Number ▾

[Apply](#)

Parameter	Description
Network Name (SSID)	<p>It specifies the Wi-Fi name of the device.</p> <p>A maximum of 32 characters are allowed in a Wi-Fi name. Only the following characters are allowed:</p> <ul style="list-style-type: none"> • Digits • Uppercase and lowercase letters • Space

Parameter	Description
	<ul style="list-style-type: none"> • ! # () + - . / % = ? @ ^ _ { } ~ <p>A Wi-Fi name cannot start or end with a space.</p>
SSID Broadcast	It specifies whether to broadcast the Wi-Fi name of the device. If the Wi-Fi name is not broadcast, a wireless client cannot detect it. To connect the wireless client to the device, you must manually enter the Wi-Fi name on the client.
Security Mode	<p>It specifies the security mode of the Wi-Fi network.</p> <ul style="list-style-type: none"> • OPEN: No authentication or encryption is performed. In this mode, private information may be intercepted by unauthorized individuals. Therefore, it is not recommended. • WPA2(AES)-PSK: WPA2-PSK is used for authentication, which is the more secure version of WPA-PSK based on the 802.11i standard. AES is used for encryption. • WPA-PSK/WPA2-PSK: WPA-PSK or WPA2-PSK is used for authentication, where WPA2-PSK is the more secure version of WPA-PSK based on the 802.11i standard.
Wi-Fi Key	<p>It specifies the password corresponding to the selected security mode.</p> <p>Only the following characters are allowed:</p> <ul style="list-style-type: none"> • Digits • Uppercase and lowercase letters • ! # () + - . / % = ? @ ^ _ { } ~
Display Password	It specifies whether to display the password in plain text.
QR Code	You can scan the QR code using the Wi-Fi scan function of your mobile phone (as an example) to connect to the Wi-Fi.
Show On Lcd	<p>It specifies whether to display the SSID and Wi-Fi Key on the LCD screen (only for 4G185).</p> <p>When you select Yes, the SSID and Wi-Fi Key will show on the LCD screen.</p> <p>When you select No, the SSID and Wi-Fi Key will not show on the LCD screen.</p>
Max Station Number	<p>It specifies the maximum number of wireless clients allowed to connect to the device.</p> <p>By default, it is set to 10. When Multi SSID Switch is enabled, this parameter is changed to 5 automatically.</p>

5.3.2 Guest SSID

When the **Multi SSID Switch** is enabled, you can set parameters of the **Guest SSID**.

In this case, you can press the **Power** button for three times to show the **Guest SSID** and corresponding **Wi-Fi Key**.

Click **Wi-Fi Settings** > **Guest SSID** to enter the page.

Multi SSID Switch Enable Disable Apply

Guest SSID

Network Name(SSID) *

SSID Broadcast

Security Mode ▼

Wi-Fi Key *

Display Password



Max Station Number ▼

Apply

To configure the guest SSID, please refer to the [parameter description](#) of the main SSID above.

5.3.3 WPS

WPS (Wi-Fi Protected Setup) is a standard that allows users to set up a wireless network in an easy and secure way without specific configuration, such as: SSID, security mode and password.

If you have a WPS-supported device (such as Android phones or tablets), you can connect your device to the mobile Wi-Fi through two methods: **PIN** and **PBC** (Push Button Configuration).

Click **Wi-Fi Settings > WPS** to enter the page.

Through the PIN

This mode requires a PIN code generated by the client.

- Step 1** Enable the WPS function of the client.
- Step 2** Obtain the PIN code generated by the client.
- Step 3** [Log in to the web UI of the device.](#)
- Step 4** Choose **Wi-Fi Settings > WPS**.
- Step 5** Select **PIN** for **WPS**, and enter the PIN code in the **PIN** text box.
- Step 6** Click **Apply**.

---End

Through the PBC

- Step 1** Perform either of the following operations:
 - Hold down the **WPS** button for 3 seconds.
 - [Log in to the web UI of the device](#), choose **Wi-Fi Settings > WPS**, select **PBC** for **WPS**, and click **Apply**.
- Step 2** Within 2 minutes after the previous step, enable the WPS function of the client.

---End

After the WPS negotiation, your device will be automatically connected to the wireless network of the mobile Wi-Fi.

5.3.4 Internet Wi-Fi

On this page, you can connect the mobile Wi-Fi to an upstream Wi-Fi hotspot available in the network. This function helps you to save the mobile data of your SIM card.

Click **Wi-Fi Settings** > **Internet Wi-Fi** to enter the page.

Connect to a Wi-Fi hotspot



TIP

- To configure **Internet Wi-Fi**, you need to disable **Multi SSID Switch** first.
- Please make sure that the IP address of Wi-Fi hotspot you have connected is not in the range of this device IP address, or you won't have access to internet via the Wi-Fi hotspot.

Step 1 Choose **Wi-Fi Settings** > **Internet Wi-Fi** to enter the configuration page.

Step 2 Enable **Internet Wi-Fi Switch**, and click **Apply**.

“WAN connected” appears as the current status.

Step 3 Add a Wi-Fi Hotspot.

1. Click **Add** in the Wi-Fi Hotspot module, then the device starts scanning Wi-Fi hotspots.

Wi-Fi Hotspot

Option	SSID	Signal	Security Mode
?			

2. After scanning, select one SSID in the SSID list, which is **Demo Test** in this example.
3. Select a **Security Mode** and **WPA Algorithm**, enter the **Wi-Fi Key**, and click **Apply**.

Add Wi-Fi Hotspot



Network Name(SSID) *

Security Mode

WPA Algorithms TKIP AES AUTO

Wi-Fi Key *

Display Password

SSID	Signal	Security Mode
<input checked="" type="radio"/> Demo Test		WPA2-PSK
<input type="radio"/> NOVA_MUY2_A3		WPA2-PSK
<input type="radio"/> Tenda-2.4G-3E49		WPA-PSK/WPA2-PSK

Step 4 Connect to the Wi-Fi hotspot.

- (1) Select the SSID you want to connect.
- (2) Click **Connect** to connect the mobile Wi-Fi to the Wi-Fi hotspot.

When the **Current Status** becomes **Wi-Fi connected**, the mobile Wi-Fi is connected to the Wi-Fi hotspot.

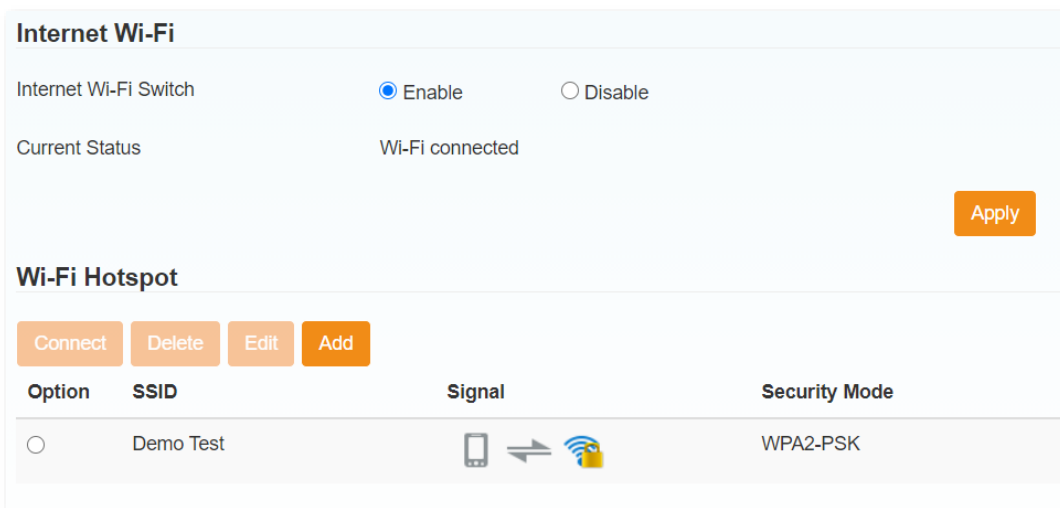
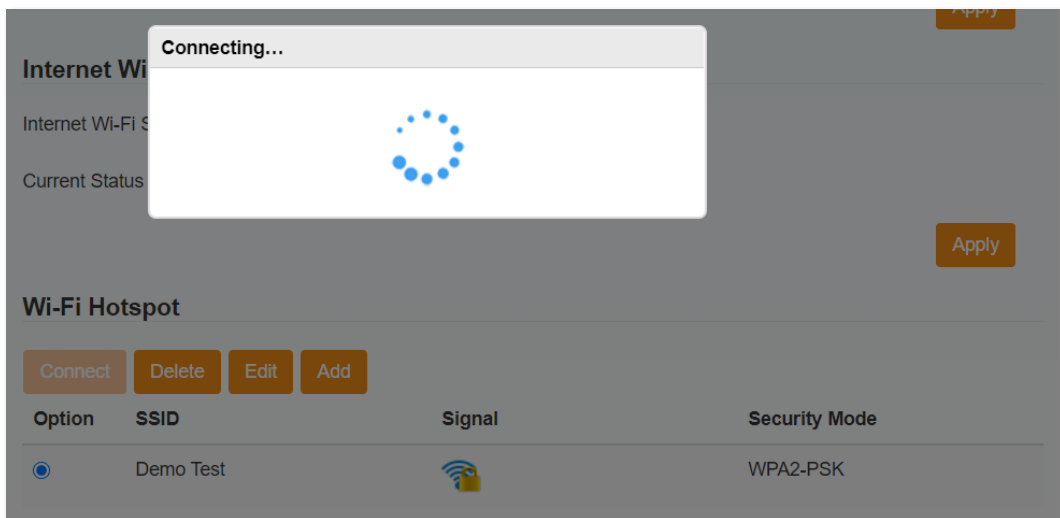

---End

If the **Wi-Fi Key** you entered in [Step 3](#) is incorrect, you can select the SSID and click **Edit** to revise the Wi-Fi Key for connection.

Edit Wi-Fi Hotspot

Network Name(SSID) *

Security Mode

WPA Algorithms TKIP AES AUTO

Wi-Fi Key *

Display Password

Disconnect from a Wi-Fi hotspot

You can select the connected SSID, and click **Disconnect** to disconnect the mobile Wi-Fi from the Wi-Fi hotspot.

Wi-Fi Hotspot

Disconnect **Delete** **Edit** **Add**

Option	SSID	Signal	Security Mode
<input checked="" type="radio"/>	Demo Test		WPA2-PSK



After the SSID is disconnected, you are allowed to delete the SSID from the list.

Wi-Fi Hotspot

Connect **Delete** **Edit** **Add**

Option	SSID	Signal	Security Mode
<input checked="" type="radio"/>	Demo Test		WPA2-PSK



5.3.5 Advanced settings

On this page, you can configure the advanced Wi-Fi settings of the hotspot.

Click **Wi-Fi Settings > Advanced Settings** to enter the page.

Advanced Settings

Band Selection	2.4G
Network Mode	802.11 b/g/n ▼
Channel Bandwidth	20MHz/40MHz ▼
Country/Region Code	ITALIA ▼
Frequency (Channel)	Auto ▼

Apply

Parameter	Description
Band Selection	It specifies the wireless band of the hotspot's SSID.
Network Mode	It specifies the wireless network standards supported by the hotspot. Only the wireless clients compliant with the selected standards can connect to the hotspot.
Channel Bandwidth	It specifies the bandwidth of the operating channel of the hotspot.
Country/Region Code	It specifies the country or region where the hotspot is used.
Frequency (Channel)	It specifies the operating frequency and channel of the hotspot. The options vary according to the selected country or region. Auto is recommended to maximize wireless network transmission and coverage of the hotspot.

After the configuration, click **Apply** for the new settings to take effect. After the settings are applied, wireless clients will be reconnected to the device.

5.3.6 WLAN MAC filter

On this page, you can set a white list or a black list for some MAC addresses.

Click **Wi-Fi Settings** > **WLAN MAC Filter** to enter the page.

WLAN MAC Filter

MAC Filter Format Black List ▼

94:C6:91:29:C2:C4	D8:38:0D:56:42:18

Apply

Parameter	Description
MAC Filter Format	<p>It specifies the MAC filter rules.</p> <ul style="list-style-type: none"> • Ruleless: The WLAN MAC filter is disabled. • White List: Only allow clients in the white list to connect to the hotspot using the WLAN. • Black List: Only deny clients in the white list to connect to the hotspot using the WLAN.

Example of configuring WLAN MAC Filter

Network requirement

Only procurement personnel are allowed to connect to the Wi-Fi network of the hotspot.

Solution

The WLAN MAC Filter function can meet this requirement. Assume that the MAC addresses of computers belonging to procurement personnel are CC:3A:61:71:1B:6E, 94:C6:91:29:C2:C4 and D8:38:0D:56:42:18.

Configuration procedures

- Step 1** Click **Wi-Fi Settings > WLAN MAC Filter**.
- Step 2** Set **MAC Filter Format** to **White List**.
- Step 3** Enter the MAC addresses of procurement personnel's computers, which are **CC:3A:61:71:1B:6E**, **94:C6:91:29:C2:C4** and **D8:38:0D:56:42:18** in this example, and click **Apply**.

The screenshot shows the 'WLAN MAC Filter' configuration window. At the top, the title is 'WLAN MAC Filter'. Below it, the 'MAC Filter Format' is set to 'White List' in a dropdown menu. There are two columns of input fields for MAC addresses. The first column contains three fields with the following values: 'CC:3A:61:71:1B:6E', 'D8:38:0D:56:42:18', and an empty field. The second column contains three fields with the following values: '94:C6:91:29:C2:C4', an empty field, and another empty field. In the bottom right corner, there is an orange 'Apply' button.

---End

Verification

Only clients with the above-mentioned MAC addresses can connect to the Wi-Fi network of the hotspot while other clients are blocked.

5.4 Connected devices

On this page, you can view the basic information of the connected devices, or block some connected devices.



Connected Devices								
All of wireless devices connected to this router will show on the page, including device name and MAC address								
Wireless Access Device								
No.	Timestamp	Host Name	IP Address	Mac Address	Duration(active)	Rx	Tx	Operation
1	2022-03-01 14:37:21	LAPTOP- LNSBROQH	192.168.0.100	F8E4E310F8B1A	22m:13s	6.96 MB	21.15 MB	Block
2	2022-03-01 13:39:30	LAPTOP- LNSBROQH	192.168.0.100	F8E4E310F8B1A	14s	39.75 KB	45.78 KB	Block
3	2022-03-01 14:15:06	LAPTOP- LNSBROQH	192.168.0.100	F8E4E310F8B1A	4m:8s	1.04 MB	2.01 MB	Block
4	2022-03-01 14:10:51	LAPTOP- LNSBROQH	192.168.0.100	F8E4E310F8B1A	3s	1.32 KB	1.69 KB	Block

Parameter	Description
Connected Devices (1 wireless)	It specifies the number of currently connected devices and the connection type.

Parameter	Description
Timestamp	It specifies the time when a client device is connected to the hotspot.
Duration	It specifies the connection duration of the client device to the hotspot.
Rx/Tx	It specifies the received/transmitted data between the client device and the hotspot.
Operation	You can click the Block button to block certain device from connecting to the hotspot.

5.5 Data management

On this page, you can set data use limits and the reminding condition (by **Data** or **Time**).

Click **Statistics > Not set, click Settings** to enter the page.

The operation is similar to what you usually do on your mobile phone.

The parameters you set will also appear on the LCD screen (4G185).

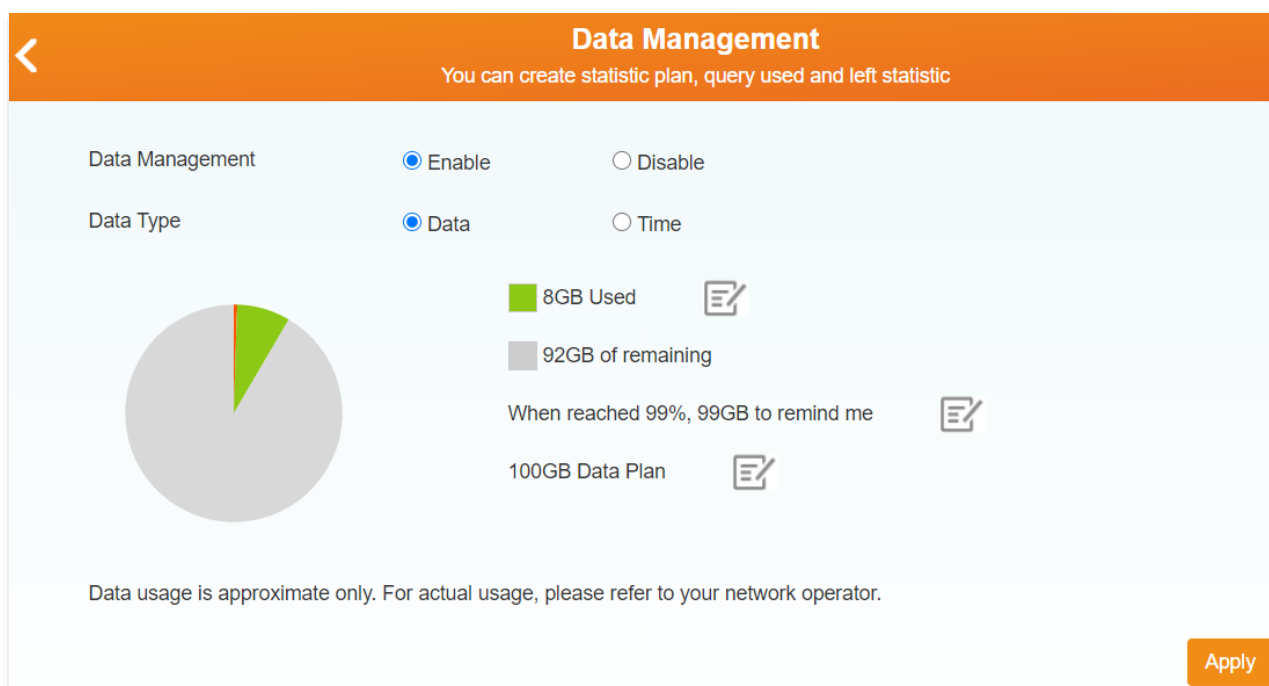



Set data use limit

- Step 1** Set **Data Management** to **Enable**, and click **Apply**.
- Step 2** Select a **Data Type**, such as **Data**.
- Step 3** Click the upper  to fill in the used data, such as **10 GB**.





TIP
The mobile Wi-Fi supports data calibration. If the data displayed on the web page is different from the actual used, you can modify the used data by this operation.

- Step 4** Click the lower  to set the total data plan, such as **100 GB**.
- Step 5** Click the middle  to set the percent upon which the reminding takes effect, such as **99%**.
- Step 6** Click **Apply**.

Data Management Enable Disable

Data Type Data Time



10GB Used 

90GB of remaining

When reached 99%, 99GB to remind me 

100GB Data Plan 

Data usage is approximate only. For actual usage, please refer to your network operator.

Apply

---End

5.6 Status information

Here, you can view status information of the SIM card and relevant wireless network.

You can click **Detail Information** to check more details.

The screenshot shows a 'Status Information' screen with an orange background. It lists several parameters and their corresponding values:

- SIM Card Number: +86136916 [blurred]
- IMEI: 86156805126 [blurred]
- RSRQ: 26
- SINR: 33
- PCI: 124
- IMSI: 46000172191 [blurred]
- Signal Strength: -82 dBm
- Network Name(SSID): Tenda_00FF4C

At the bottom right of the screen, there is a 'Detail Information' button with a right-pointing arrow.

Parameter	Description
SIM Card Number	It specifies the mobile number (Format: <i>Country code + Mobile number</i>) of the SIM card.
IMEI	It specifies the International Mobile Equipment Identity (IMEI) of the device.
IMSI	It specifies the International Mobile Subscriber Identity (IMSI) of the device.
Signal Strength	It specifies the signal strength of the connected mobile network. Stronger signal strength (-60 dBm is better than -70 dBm) leads to better networking experience.
Network Name (SSID)	It specifies the Wi-Fi name (SSID) of the device. The default Wi-Fi name is Tenda_XXXXXX, where XXXXXX indicates the last six characters of the MAC address of the device.
Max Access Number	It specifies the maximum number of clients that can be connected to the device.
Wi-Fi Coverage	It specifies the Wi-Fi range setting of the device, including short Wi-Fi coverage , medium Wi-Fi coverage and long Wi-Fi coverage . You can change this parameter on Advanced Settings > Power-save .

Parameter	Description
LAN Domain	It specifies the LAN domain of the device. The LAN domain maintains a connection between domain names and IP addresses. You can access this web UI by clicking the shortcut corresponding to the LAN domain on the desktop of your computer.
IP Address	It specifies the LAN IP address of the device.
WAN IP Address	It specifies the WAN IP address of the device.
Software Version	It specifies the software version of the device.
Hardware Version	It specifies the hardware version of the device.
RSRP	It specifies the Reference Signal Received Power (RSRP) of the device.
RSRQ	It specifies the Reference Signal Received Quality (RSRQ) of the device.
RSSI	It specifies the Received Signal Strength Indicator (RSSI) of the device. It helps the device to connect to a wireless network with stronger signal.
SINR	It specifies the Signal to Interference plus Noise Ratio of the device. The larger the number, the stronger the signal.
Cell ID	It specifies the Cell ID of the SIM card, which helps locate the device.
PCI	It specifies the Physical Cell ID of the device.
Band	It specifies the operating band upon which the wireless network operates.
 (QR code below)	You can scan the QR code below Status Information to view the SSID and Wi-Fi key.

6 SMS

This module enables you to manage SMS messages and configure SMS settings.

6.1 Device SMS

On this page, you can view, write, delete and refresh SMS messages received by the mobile Wi-Fi.

Click **SMS > Device** to enter the page.

Device	Number	Content	Time
SIM Card	10086 (6)	[REDACTED]	2022/03/01 16:00:58
	10086033 (3)	[REDACTED]	2022/03/01 08:37:51
Settings	1065806010023 (1)	[REDACTED]	2022/02/28 10:46:39
	10086055 (1)	[REDACTED]	2022/02/28 08:32:33
	123790755 (1)	[REDACTED]	2022/02/26 21:47:24
	10658888602 (1)	[REDACTED]	2022/02/25 08:39:17
	10658888 (1)	[REDACTED]	2022/02/25 08:39:17

Parameter	Description
New	It is used to create a new SMS message.
Delete	It is used to delete SMS messages.
Refresh	It is used to update the SMS message list.

View and reply to messages

- Step 1** Click an SMS message to enter a dialog box.
- Step 2** You can scroll up and down to see all the history messages between the contact and you.
- Step 3** To reply, type a message (such as **Hello World**) in the text box, and click **Send**. If you click **Back** instead, the message will be saved as a draft.



---End

Write a new SMS message

- Step 1** Click **New** to enter a dialog box.
- Step 2** Enter the mobile numbers of the recipients (You can choose 5 contacts at most.).
- Step 3** Type a message (such as **Hello World**) in the text box, and click **Send**. If you click **Back** instead, the message will be saved as a draft.



NOTE

A message can consist of a maximum of 765 characters. You can refer to the counter below the message text box for the remaining number of characters that can be entered.

---End

If the delivery report function on the SMS Settings module is enabled, a delivery message appears in the lower-right corner as well.

Delete an SMS message

Step 1 Select the SMS message.

Step 2 Click **Delete**.

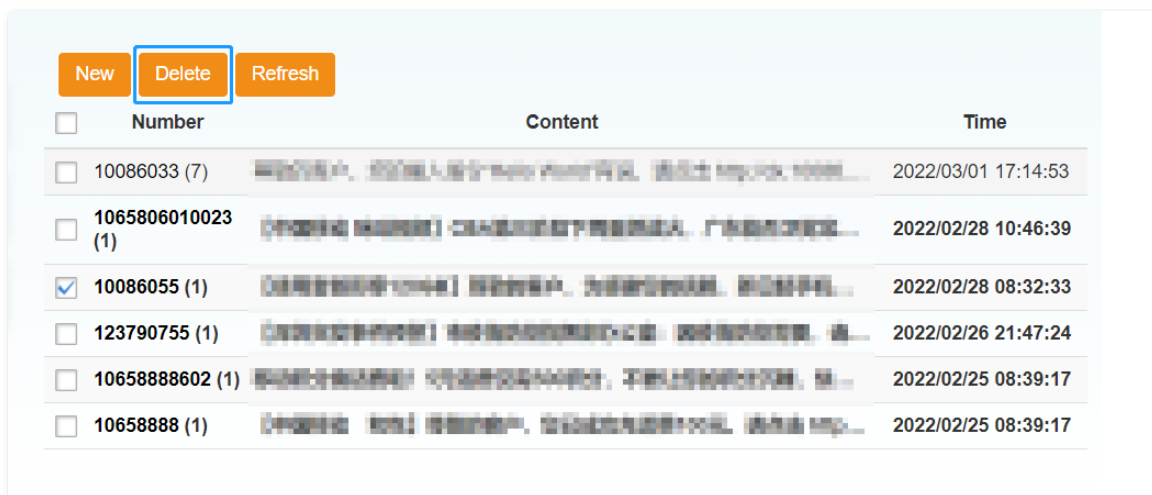

Step 3 Click **Yes** in the dialog box that appears.

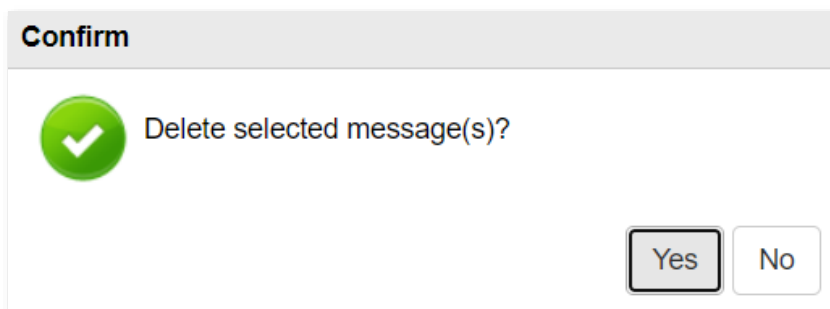

TIP

You can also delete multiple messages by selecting multiple check boxes, or you can delete all messages by selecting the top check box.

---End

6.2 SIM SMS

On this page, you can view and delete the SMS messages stored in the SIM card. The operations are same as those of the **Device SMS**.

Click **SMS > SIM Card** to enter the page.

Device	Delete		
	Number	Content	Time
SIM Card	<input checked="" type="checkbox"/> 10086033	【中国移动】2021-10-30 19:00:22 尊敬的客户，您好！中国移动APP现已上线，您可以通过手机扫码或访问www.10086.com下载。中国移动APP为您提供更便捷、更丰富的服务，包括话费充值、流量查询、业务办理等。立即下载，畅享移动生活！	2021/10/30 19:00:22
Settings	<input type="checkbox"/> 1065813914759...	【中国移动】尊敬的客户，您好！中国移动APP现已上线，您可以通过手机扫码或访问www.10086.com下载。中国移动APP为您提供更便捷、更丰富的服务，包括话费充值、流量查询、业务办理等。立即下载，畅享移动生活！	2021/10/26 11:01:54
	<input type="checkbox"/> 10086055	【中国移动】尊敬的客户，您好！中国移动APP现已上线，您可以通过手机扫码或访问www.10086.com下载。中国移动APP为您提供更便捷、更丰富的服务，包括话费充值、流量查询、业务办理等。立即下载，畅享移动生活！	2021/10/26 09:58:54
	<input type="checkbox"/> 1065813914759...	【中国移动】尊敬的客户，您好！中国移动APP现已上线，您可以通过手机扫码或访问www.10086.com下载。中国移动APP为您提供更便捷、更丰富的服务，包括话费充值、流量查询、业务办理等。立即下载，畅享移动生活！	2021/10/25 19:32:58
	<input type="checkbox"/> 1065813914756...	【中国移动】尊敬的客户，您好！中国移动APP现已上线，您可以通过手机扫码或访问www.10086.com下载。中国移动APP为您提供更便捷、更丰富的服务，包括话费充值、流量查询、业务办理等。立即下载，畅享移动生活！	2021/10/23 19:27:25
	<input type="checkbox"/> 10086	【中国移动】尊敬的客户，您好！中国移动APP现已上线，您可以通过手机扫码或访问www.10086.com下载。中国移动APP为您提供更便捷、更丰富的服务，包括话费充值、流量查询、业务办理等。立即下载，畅享移动生活！	2021/10/23 17:53:07
	<input type="checkbox"/> 10086033	【中国移动】2021-10-21 19:14:41 尊敬的客户，您好！中国移动APP现已上线，您可以通过手机扫码或访问www.10086.com下载。中国移动APP为您提供更便捷、更丰富的服务，包括话费充值、流量查询、业务办理等。立即下载，畅享移动生活！	2021/10/21 19:14:41

6.3 SMS settings

On this page, you can configure the SMS settings.

Click **SMS > Settings** to enter the page.

Parameter	Description
Validity	<p>It specifies the validity period of outgoing SMS messages. The options include:</p> <ul style="list-style-type: none"> • 12 Hours: It indicates that SMS messages are retained for only 12 hours. • 1 Day: It indicates that SMS messages are retained for only 1 day. • 1 Week: It indicates that SMS messages are retained for only 1 week. • Maximum: It indicates that SMS messages are retained as long as the memory of the device has available space. Generally, the memory can store a maximum of 500 SMS messages. This number depends on the memory capacity of the device as well as the sizes of SMS messages.
Center Number	It specifies the SMS center number of your SMS service provider.
Delivery Report	It specifies whether to receive or reject a message notifying you that an SMS has been delivered to a recipient.

After changing the settings, click **Apply** to enable the new settings to take effect.

7 USSD

This module enables you to communicate with your ISP using USSD.

Click **USSD** to enter the page.



The screenshot shows a mobile application interface for USSD. At the top, there is an orange header with a back arrow on the left and the text 'USSD' on the right. Below the header, the word 'USSD' is displayed in bold. Underneath, there is a 'Send to *' label followed by a text input field containing '*555#'. To the right of the input field is an orange 'Send' button. Below the input field, there is a grey box containing a red question mark icon and a bullet point: '• You can send a command to the network (have predefined numbers or symbols), the network will be based on the instruction for you to provide the corresponding services.'

To use the USSD function, perform the following steps:

Step 1 Enter the USSD service number of your mobile carrier, such as ***555#**.

Step 2 Click **Send**.

The response from the mobile carrier appears. See the following figure.



Step 3 Send the number of a menu item to access the menu.

Step 4 Send other commands according to the responses from the carrier.

---End

8 Advanced Settings

8.1 Power-save

Here, you can adjust the Wi-Fi performance and Wi-Fi Sleep time to save battery life.

Click **Advanced Settings** > **Power-save** to enter the page.

Parameter	Description
Wi-Fi Coverage	<p>It specifies the Wi-Fi coverage settings, including Short Wi-Fi Coverage, Medium Wi-Fi Coverage and Long Wi-Fi Coverage.</p> <p>Shorter Wi-Fi coverage leads to better battery life.</p>

Parameter	Description
Sleep after	<ul style="list-style-type: none">• If the device has no wireless connection or USB connection within the specified period, which can be 5 minutes, 10 minutes, 20 minutes, 30 minutes, 1 hour or 2 hours, the device turns to the sleep mode and the Wi-Fi network becomes unavailable. You can press the Power button or connect it to a computer using the USB cable to wake it up.• If the device is set to Never Sleep, the Wi-Fi network is always available, but the device will turn to the low power mode after 10 minutes when there is no wireless connection.

8.2 Router

Here, you can configure router settings of the device.

Click **Advanced Settings** > **Router** to enter the page.



- Before configuring the router settings, you need to disconnect the device from network first (Turn **Connect Status** to **Off** on the home page).
- The parameters with asterisks are mandatory.

<
Advanced Settings

Power-save

Router

 Firewall

 Update

 SD Card

Router

IP Address *

Subnet Mask *

DHCP Server Enable Disable

DHCP IP Pool * -

DHCP Lease Time *

Apply

Parameter	Description
IP Address	It specifies the LAN IP address of the device. You can access the management web UI of the device through this IP address.
Subnet Mask	It specifies the subnet mask of the LAN IP address of the device.
DHCP Server	It specifies whether to enable the DHCP server function of the device. <ul style="list-style-type: none"> • Enable: The device allocates IP addresses to connected clients. • Disable: The device does not allocate IP addresses to connected clients, and the IP address must be entered manually for each client.
DHCP IP Pool	It specifies the IP address range that can be assigned to clients of the device.
DHCP Lease Time	It specifies the validity period of an IP address assigned to a client of the device. After an IP address expires, the device can assign it to any client.



If you have changed the LAN IP address of the device:

- Use the new IP address to access the web UI of the device.
 - Set the new IP address as the gateway IP address of a client for which IP address settings are configured manually.
-

8.3 Firewall

In this module, you can configure the following firewall related functions of the device to protect your network from viruses, worms and malicious activities on the internet.

- [Port filtering](#)
- [Port mapping](#)
- [Port forwarding](#)
- [UPnP](#)
- [DMZ](#)

8.3.1 Port filtering

Here, you can set port filtering rules to allow or reject certain data packets.

Click **Advanced Settings > Firewall > Port Filtering** to enter the page.

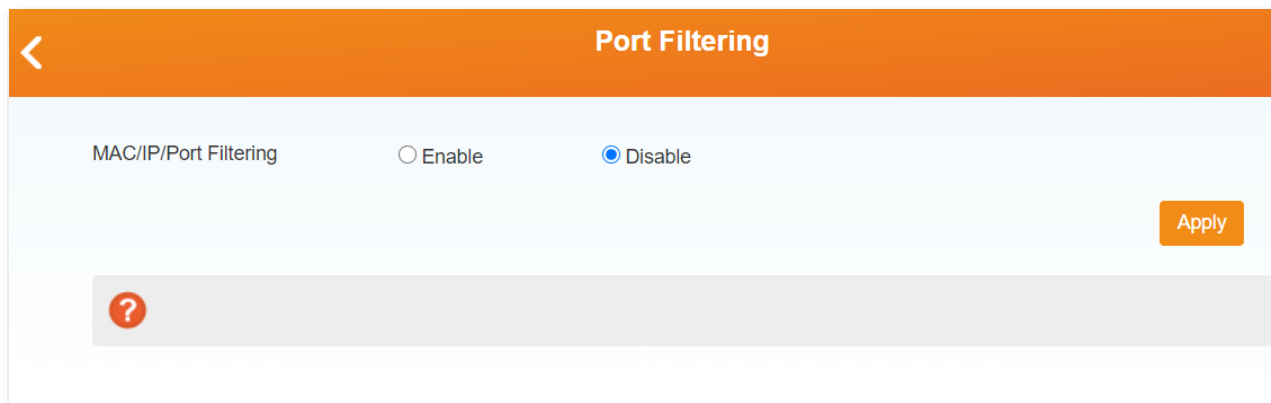

Set a port filter rule

To set a port filtering rule, perform the following steps:



A maximum of 10 port filtering rules are allowed for IPv4 and IPv6 respectively.

Step 1 Set **MAC/IP/Port Filtering** to **Enable**.

Default Policy appears.

Step 2 Set **Default Policy** to **Accepted** if you want to allow all the packets not matching the port filtering rule, or to **Dropped** if you want to reject all the packets not matching the port filtering rule.

Step 3 Click **Apply**.

The parameters of port filtering rules appear.

MAC/IP/Port Filtering Settings

IP Settings IPv4 IPv6

Mac Address (e.g., 00:1E:90:FF:FF:FF)

Source IP Address

Dest. IP Address

Protocol

Source Port Range * - (1~65535)

Dest. Port Range * - (1~65535)

Action Accept Drop

Comment *

Apply

Parameter	Description
IP Settings	It specifies whether the filtering rule is applicable to IPv4 or IPv6.
MAC Address	It specifies the MAC address of the client whose packets are to be filtered.
Source IP Address/Source IPv6 Address	It specifies the source IP address by which packets are filtered.
Dest. IP Address/Dest. IPv6 Address	It specifies the destination IP address by which packets are filtered.
Protocol	It specifies the packet transmission protocol, including TCP , UDP or ICMP .
Source Port Range	It specifies the source port range by which packets are filtered.
Dest. Port Range	It specifies the destination port range by which packets are filtered.
Action	It specifies whether to accept or drop the packets matching the rule.

Parameter	Description
Comment	<p>It specifies the description of the rule.</p> <p>Only the following characters are allowed in the comment:</p> <ul style="list-style-type: none"> • Digits • Uppercase and lowercase letters • ! # () + - . / % = ? @ ^ _ { } ~



The parameters with asterisks are mandatory.

Step 4 Set the parameters.

Step 5 Click **Apply**.

The rule appears in the **Current MAC/IP/Port Filtering Rules in System** section.

Current MAC/IP/Port Filtering Rules in System							
<input type="checkbox"/>	Mac Address	IP Type	Source IP Address	Dest. IP Address	Protocol	Source Port Range	Dest. Port Range
<input type="checkbox"/>	14:23:45:21:F4:E2	IPv4	192.168.0.78	192.168.5.98	TCP	443 - 443	443 - 443



- The device matches a packet with rules in descending order. If the device identifies a rule matching the packet, it does not match the packet with the rest of the rules.
- If a packet does not match any rule, the packet is accepted.

---End

Delete port filtering rules

To delete port filtering rules, perform the following steps:

Step 1 In the **Current MAC/IP/Port Filtering Rules in System** section, select the port filtering rules to be deleted. If you want to delete all rules, select the check box of the entire list.

Step 2 Click **Delete**.

Step 3 Click **Yes** in the pop-up dialog box that appears.

---End

8.3.2 Port mapping

Here, you can map an external port to an internal port, so that applications using the internal port (such as a web server) is accessible from the internet.

Click **Advanced Settings > Firewall > Port Mapping** to enter the page.

Set a port mapping rule

To set a port mapping rule, perform the following steps:



TIP

The maximum number of port mapping rules is 10.

Step 1 Set **Port Mapping Settings** to **Enable**.

Step 2 Click **Apply**.

The parameters of port mapping rules appear.

Parameter	Description
Src. Port	It specifies the external port to be mapped onto an internal port.
Dest. IP Address	It specifies the IP address corresponding to the internal port.
Dest. Port	It specifies the internal port.
Protocol	It specifies the packet transmission protocol.
Comment	<p>It specifies the description of the port mapping rule.</p> <p>Only the following characters are allowed in the comment:</p> <ul style="list-style-type: none"> • Digits • Uppercase and lowercase letters • ! # () + - . / % = ? @ ^ _ { } ~



The parameters with asterisks are mandatory.

Step 3 Set the parameters.

Step 4 Click **Apply**.

The rule appears in the **Current Port Mapping Rules in System** section.

Current Port Mapping Rules in System					
<input type="checkbox"/>	Src. Port	Dest. IP Address	Dest. Port	Protocol	Comment
<input type="checkbox"/>	80	192.168.0.2	56	TCP+UDP	HTTP

[Delete](#)

---End

Delete port mapping rules

To delete port mapping rules, perform the following steps:

Step 1 In the **Current Port Mapping Rules in System** section, select the port mapping rules to be deleted. If you want to delete all rules, select the check box of the entire list.

Step 2 Click **Delete**.

Step 3 Click **Yes** in the dialog box that appears.

---End

8.3.3 Port forwarding

Here, you can configure port forwarding to enable external computers to access WWW, FTP or other services provided by LAN.

Click **Advanced Settings > Firewall > Port Forwarding** to enter the page.

Set a port forwarding rule

To set a port forwarding rule, perform the following steps:



A maximum of 10 port forwarding rules are allowed.

Step 1 Set **Virtual Server Settings** to **Enable**.

Step 2 Click **Apply**.

The parameters of port forwarding rules appear.

Parameter	Description
IP Address	It specifies the source IP address to be forwarded.
Port Range	It specifies the range of port numbers to be forwarded.
Protocol	It specifies the packet transmission protocol for forwarding.
Comment	It specifies the description of the port forwarding rule. Only the following characters are allowed in the comment: <ul style="list-style-type: none"> • Digits • Uppercase and lowercase letters • ! # () + - . / % = ? @ ^ _ { } ~



The parameters with asterisks are mandatory.

Step 3 Set the parameters.

Step 4 Click **Apply**.

The rule appears in the **Current Virtual Servers in System** section.

Current Virtual Servers in system				
<input type="checkbox"/>	IP Address	Port Range	Protocol	Comment
<input type="checkbox"/>	192.168.0.101	80 - 100	TCP+UDP	Office

[Delete](#)

---End

Delete port forwarding rules

To delete port forwarding rules, perform the following steps:

Step 1 In the **Current Virtual Servers in System** section, select the port forwarding rules to be deleted. If you want to delete all the rules, select the check box of the entire list.

Step 2 Click **Delete**.

Step 3 Click **Yes** in the dialog box that appears.

---End

Example of configuring port forwarding rule

Network requirement

You have set up an FTP server (such as in a computer) within your LAN.

Requirement: Open the FTP server to internet users and enable external computers to access the resources of the FTP server from the internet.

Solution

You can configure a port forwarding rule to meet this requirement.

Assume that the information of the FTP server includes:

- IP address: 192.168.0.136
- Service port: 21
- Protocol: TCP

and the WAN IP address of the hotspot: 183.38.7.216.



Before the configuration, ensure that the WAN port of the hotspot obtains a public IP address; if the WAN port obtains a private IP address or an intranet IP address assigned by the ISP (starting with 100), the function may not take effect. Commonly-used IPv4 private IP addresses include 10.0.0.0 to 10.255.255.255, 172.16.0.0 to 172.31.255.255, and 192.168.0.0 to 192.168.255.255.

Configuration procedures

- Step 1** Click **Advanced Settings > Firewall > Port Forwarding**.
- Step 2** Set **Virtual Server Settings** to **Enable**, and click **Apply**.
- Step 3** Set **IP Address** to **192.168.0.136**.
- Step 4** Set **Port Range** to **21-21**.
- Step 5** Select **TCP** as the **Protocol**.
- Step 6** Fill in the **Comment**, such as **FileServer**, and click **Apply**.

Port Forwarding Settings

IP Address * (e.g., 192.168.0.101)

Port Range * - (1~65535)

Protocol ▼

Comment *

Verification

External computers can access the intranet through the IP format **Server Type://Your Hotspot's WAN IP:Port Number**. Here in this example, external computers can access the file in the FTP server within the LAN by entering [ftp:// 183.38.7.216:21](ftp://183.38.7.216:21) in a browser.

8.3.4 UPnP

Universal Plug and Play (UPnP) is a set of networking protocols that allows networked devices, such as PCs, printers, internet gateways, Wi-Fi access points and mobile devices, to seamlessly discover each other's presence on the network and establish functional network services for data sharing, communications, and entertainment.

Although UPnP facilitates networking among different devices, note that this function may raise the risk of being attacked. Use this function with caution.

Click **Advanced Settings > Firewall > UPnP** to enter the page.

UPnP Settings

UPnP Settings Enable Disable

?

8.3.5 DMZ

In some cases, you may need to have your device completely exposed to external networks for

bidirectional communication. To do so, set it as a DMZ host.

If a client cannot access the internet properly, you can try this function. If the DMZ function is enabled for a specific client, the client is not protected by the firewall of the device. Therefore, use this function with caution.

Click **Advanced Settings** > **Firewall** > **DMZ** to enter the page.

To use the DMZ function, perform the following steps:

Step 1 Set **DMZ Settings** to **Enable**.

Step 2 Set **IP Address** to the IP address of the client that requires the DMZ function.

Step 3 Click **Apply**.

DMZ Settings

DMZ Settings Enable Disable

IP Address *

Apply

?

---End

8.4 Update

Here, you can update the software version of the device manually or automatically.

Click **Advanced Settings** > **Update** to enter the page.

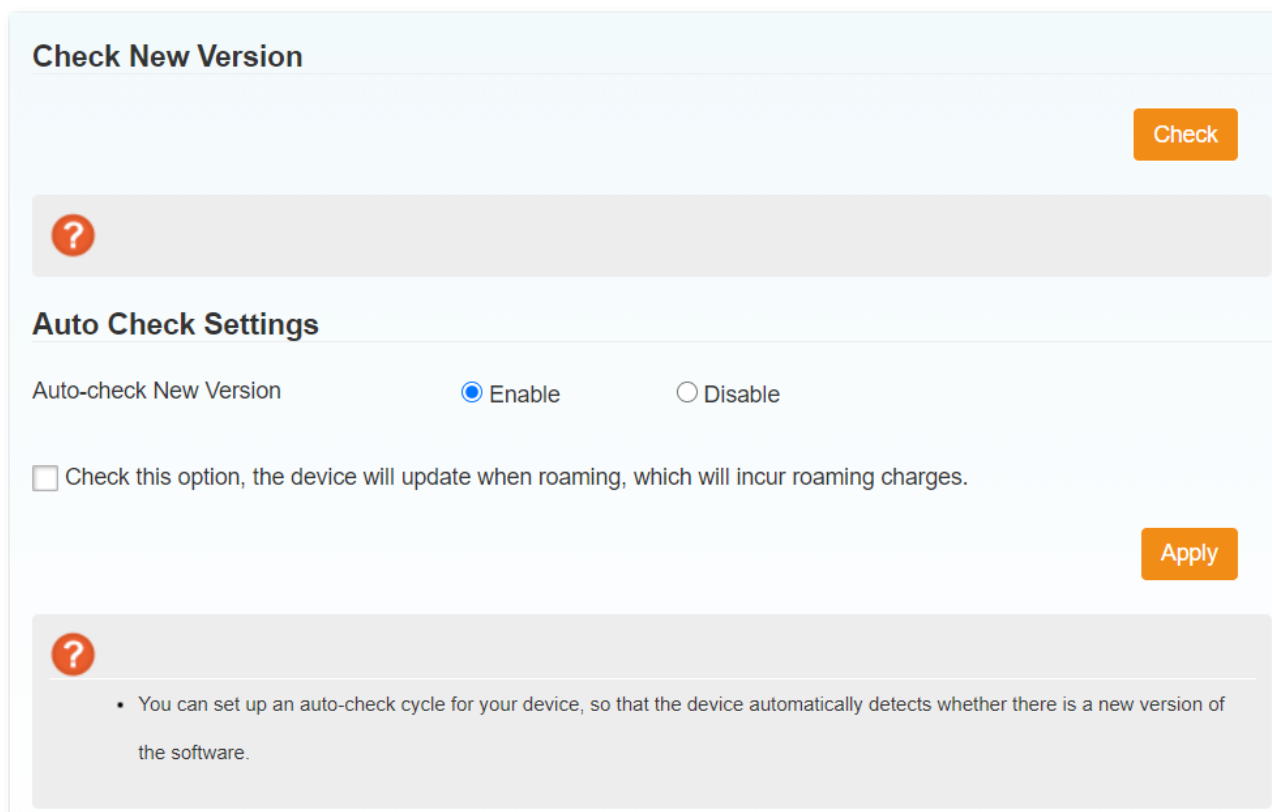

Check New Version

Check

?

Auto Check Settings

Auto-check New Version Enable Disable

Check this option, the device will update when roaming, which will incur roaming charges.

Apply

?

- You can set up an auto-check cycle for your device, so that the device automatically detects whether there is a new version of the software.

- To update manually, you can click the **Check** button for obtaining a new version immediately.
- To update automatically, you can select **Enable** and click **Apply**. Note that the update during roaming will incur roaming charges.

8.5 SD card and HTTP share

Here, you can configure the Micro SD card installed on the device for sharing resources with clients.

Click **Advanced Settings > SD Card** to enter the page.



To use this function, you need to prepare an SD card yourself. There is no SD card in the package content.

The devices only support an SD card with a maximum capacity of 32 GB. Make sure your SD card does not exceed 32 GB.



8.5.1 SD card

On this page, you can set the working mode of the Micro SD card.

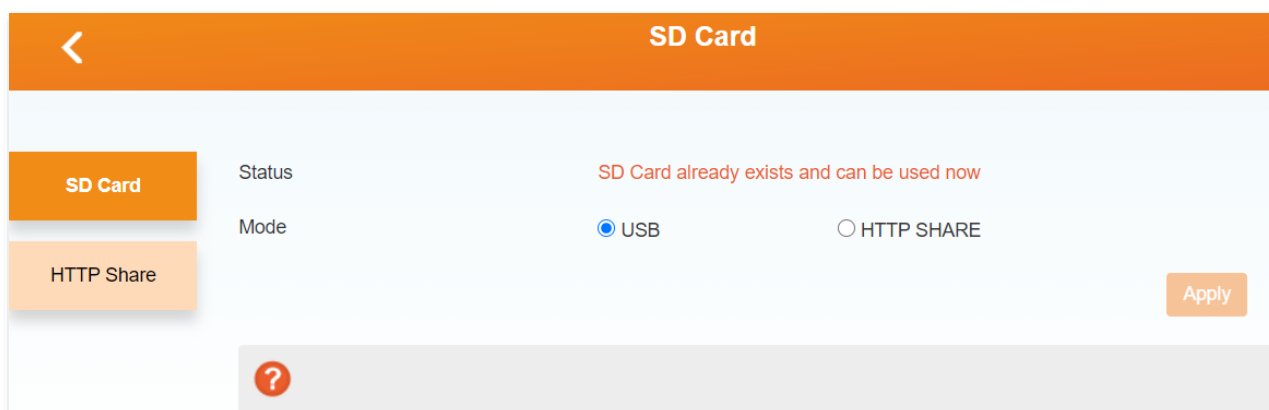
The device support two working modes: **USB** and **HTTP SHARE**.



Parameter	Description
Status	It specifies whether a Micro SD card is available.
Mode	<p>It specifies the mode in which the Micro SD card works.</p> <ul style="list-style-type: none"> USB It indicates that the Micro SD card is used as a portable USB storage device of the computer to which the device is connected with a USB cable. In this mode, the Micro SD card is not accessible to wireless clients of the device. HTTP SHARE It indicates that the Micro SD card is managed using the web UI or app of the device and shared as a storage device among all clients.

Parameter	Description
	 TIP After you enable the HTTP SHARE mode, you can click  View SD card on the login page of the device to directly access the page for managing the Micro SD card without the login user name or password.
Share Setting	It specifies whether to share the Micro SD card.
File to Share	It specifies whether to share the entire Micro SD card or only a folder in it.
Access Type	It specifies whether the shared Micro SD card or folder can be read and written.
Path to Share	It specifies the path to the shared folder.  TIP / indicates that the entire Micro SD card is shared.

Use the micro SD card in USB mode

To use the Micro SD card in USB mode, perform the following steps:

- Step 1** Choose **Advanced Settings > SD Card > SD Card** on the web UI.
- Step 2** Set **Mode** to **USB**.
- Step 3** Click **Apply**.

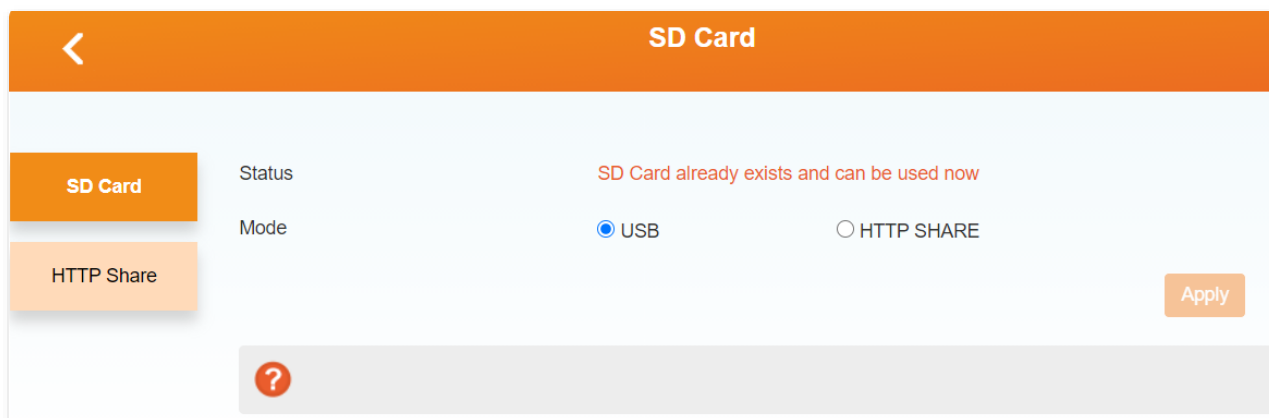

A removable disk appears in the computer folder connected to the device.

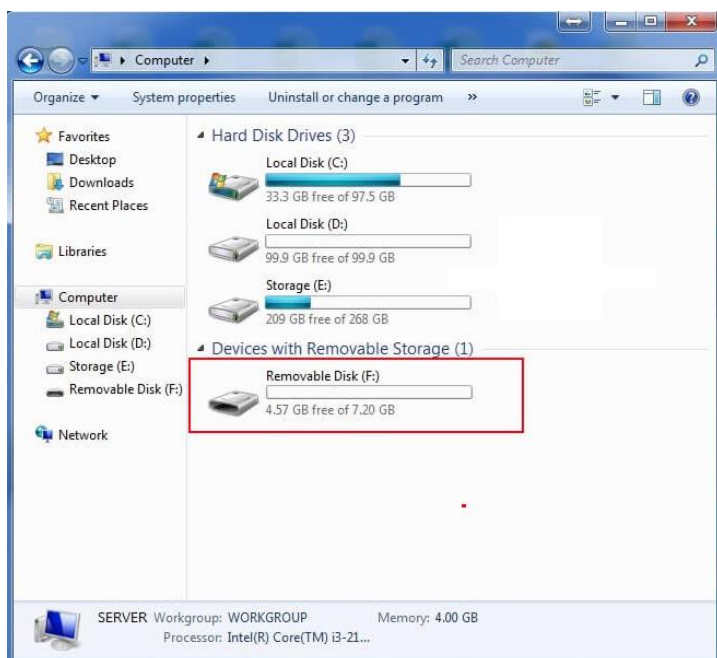

Step 4 Use the removable disk on the computer as a common portable storage device.

---End

Use the Micro SD card in HTTP SHARE mode



A Micro SD card can be used in HTTP SHARE mode only when it adopts the FAT/FAT32 file system.

To use the Micro SD card in HTTP SHARE mode, perform the following steps:

Step 1 Set **Mode** to **HTTP SHARE**.

Step 2 Set **Share Setting** to **Enable**.

Step 3 Set **File to Share** to **Entire SD Card** to share the entire Micro SD card, or to **Custom** to share only a specific folder in the Micro SD card.

Step 4 Set **Access Type** to **Read/Write** if you want the Micro SD card to be readable and writable, or to **Read Only** if you want the Micro SD card to be readable only.

Step 5 If you have set **File to Share** to **Custom**, set **Path to Share** to **/** to share the entire Micro SD card, or set **Path to Share** to a specific folder to share only the folder.

Step 6 Click **Apply**.

Status	SD Card already exists and can be used now	
Mode	<input type="radio"/> USB	<input checked="" type="radio"/> HTTP SHARE
		<input type="button" value="Apply"/>
HTTP Share Settings		
Share Setting	<input checked="" type="radio"/> Enable	<input type="radio"/> Disable
File to Share	<input checked="" type="radio"/> Entire SD Card	<input type="radio"/> Custom
Access Type	<input checked="" type="radio"/> Read/Write	<input type="radio"/> Read Only
Path to Share *	<input type="text" value="/"/>	
		<input type="button" value="Apply"/>

---End

8.5.2 HTTP share

After setting the device to HTTP SHARE mode, you can manage the SD card folder on the web UI.

Click **Advanced Settings > HTTP Share** to enter the page.

HTTP Share

SD Card Path: 21.1GB/28.87GB

<input type="checkbox"/>	Name	Rename	Download	File Size	Updated Time
<input type="checkbox"/>	20201001	Rename			2022-03-01 07:49:30
<input type="checkbox"/>	20220109	Rename			2022-02-28 07:03:36
<input type="checkbox"/>	20220221	Rename			2022-02-21 16:00:00

Parameter	Description
Path	It specifies the path to the current folder.
Root	It is used to access the root folder.

Parameter	Description
Back	It is used to access the upper-level folder.
New	It is used to create a folder
Name	It specifies the name of a folder.
Rename	It is used to rename a folder.
Download	It is used to download a file from a folder.
File Size	It specifies the size of a file.
Updated Time	It specifies the last update time of a file or folder.
Delete	It is used to delete a file or folder.
Browse	It is used to select a file to be uploaded.
Upload	It is used to upload a file.

Add a folder and file

To add a folder and file, perform the following steps:

Step 1 Click **New**, enter the name of the folder, such as **Image**, and click **Create**.

The **Image** folder is added.

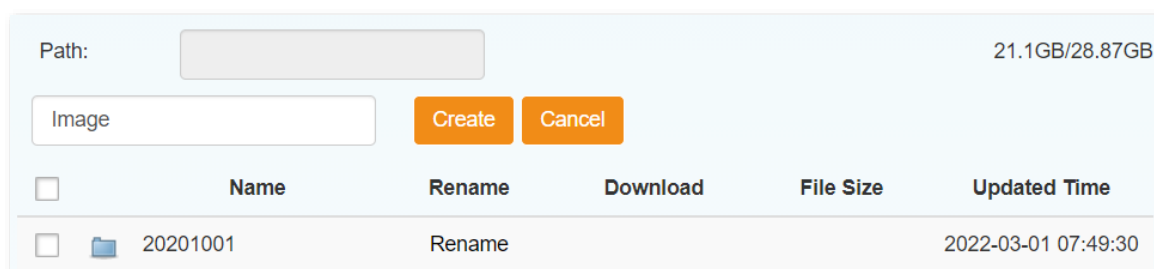

Step 2 Click **Image**, click **Browse**, select the file to be uploaded, and click **Upload**.

The file is uploaded.

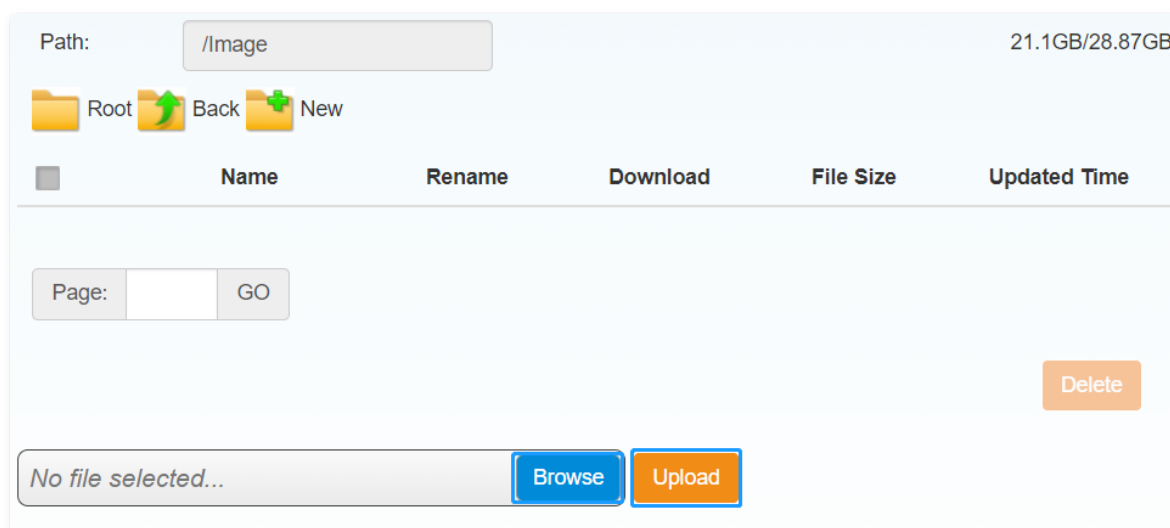

---End

Download a file

To download a file, perform the following steps:

- Step 1** Access the folder where the file resides.
- Step 2** Click  corresponding to the file.
- Step 3** Follow the instructions of your web browser to download the file.

---End

Delete a folder or file

To delete a folder or file, perform the following steps:

- Step 1** Select the check box of the folder or file.
- Step 2** Click **Delete**.
- Step 3** Click **Yes** in the dialog box that appears.

The folder or file is deleted.

---End



TIP

- To delete multiple folders or files, select their check boxes and click **Delete**.
- To delete all files and sub-folders in a folder, select the check box of the entire list and click **Delete**.

Rename a folder or file

To rename a folder or file, perform the following steps:

- Step 1** Click **Rename** in the line of the folder or file.
- Step 2** Change the name of the folder or file in the pop- up dialog box that appears.
- Step 3** Click **Yes**.

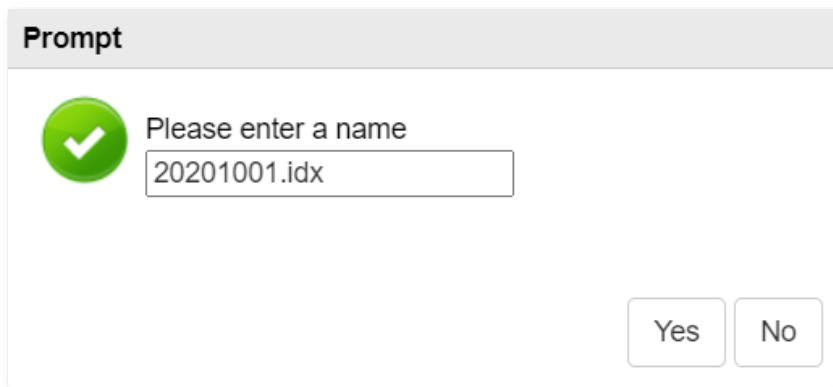

The folder or file is renamed.

---End

8.6 Others

This module consists of restart and reset of the device, turning off of the device, fast reboot function, SNTP and PIN management.

Click **Advanced Settings** > **Others** to enter the page.

8.6.1 Restart and reset

When a parameter you set does not work properly, you can try to **Restart Device** to fix this issue.

When you forget the password you set, or misconfigured some parameters, you can try to **Reset Factory Settings**. After that, you can log in to the web UI by the default password **admin**.



After the reset, all the configurations you made will be cleared. You need to reconfigure. Reset device with caution.

Restart and Reset

Please login again after rebooting or resetting router

Restart Device

Reset Factory Settings

8.6.2 Turn off device

Here, you can click **Turn Off Device** to save the battery power or data of the device.

Turn Off Device

Turn Off Device

8.6.3 Fast boot settings

With the **Fast Boot Settings** enabled, when you hold the Power button for 3 seconds, the device will start in a shorter time.

Fast Boot Settings

Fast Boot Settings Enable Disable

If enable Fast Boot function, your device will start in a short time.

8.6.4 SNTP

SNTP, short for Simple Network Protocol, displays time-related parameters. On this page, you can automatically synchronize the time according to the SNTP server or manually set the time.

SNTP

Current Local Time 2022-03-02 07:41:38 Wednesday

Time Set Mode ▼

SNTP Server1 * ▼

SNTP Server2 * ▼

SNTP Server3 * ▼

Time Zone ▼

Daylight Saving Time ▼

Parameter	Description
Current Local Time	It specifies the current local time in the place where the device is located.
Time Set Mode	It includes two options: Sntp auto Synchronization and Manual Set Time .

Parameter	Description
SNTP Server1/2/3	It specifies the SNTP servers that help the device to calibrate the time automatically.
Time Zone	It specifies the time zone of the current local time.
Daylight Saving Time	It specifies the daylight saving time of the current local time. You can enable this function as required according to the specific country or region.

8.6.5 PIN management

PIN management prevents unauthorized use of the SIM, USIM, or UIM card. If you want to change current settings, please disconnect from network first. Generally, a PIN and a PUK are provided along with a SIM card.

It is recommended to enable the PIN status when you want to increase security.

Change the PIN Status

To change the PIN status, perform the following steps:

- Step 1** Disconnect the device from your mobile network.
- Step 2** Set **PIN Status** to **Enable** or **Disable**.
- Step 3** Enter the PIN of the SIM card.



A maximum of three consecutive failed attempts are allowed. If this limit is exceeded, you need to enter the PUK of the SIM card to unlock the SIM card.

- Step 4** Click **Apply**.

Step 5 Click **Yes** in the dialog box that appears.

---End

After the **PIN Status** is set to **Enable**, the SIM card is locked each time the device starts (**PIN Lock** will appear on the screen). You need to log in to the web UI of the device, enter the PIN, and click **Next** to unlock the SIM card, so that you can use the SIM card properly. See the following figure.

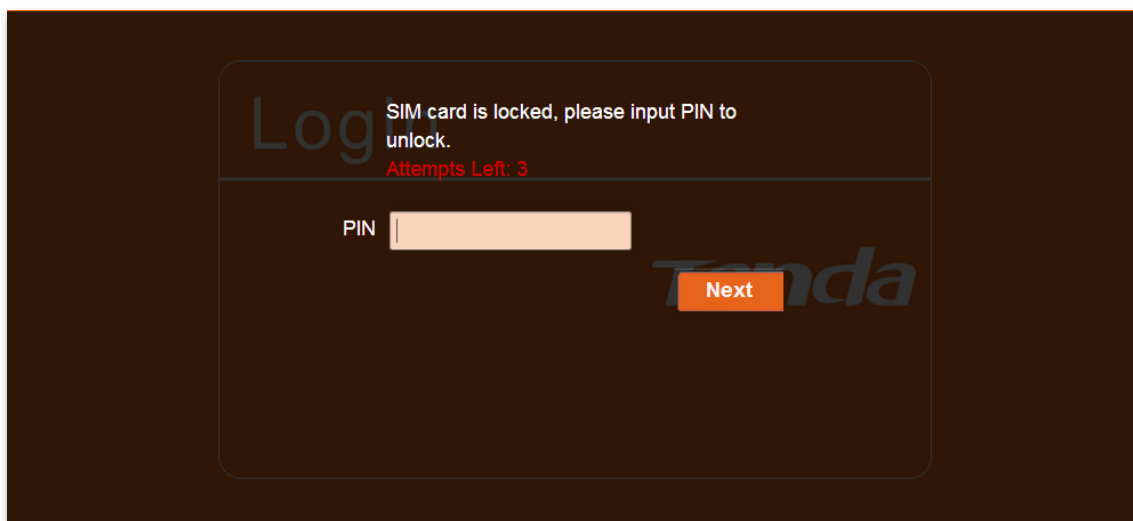

Change the PIN

To change the PIN, perform the following steps:

- Step 1** Disconnect the device from your mobile network.
- Step 2** Set **PIN Status** to **Enable**, enter the **Current PIN**, and click **Apply**.
- Step 3** Click **Change PIN**.
- Step 4** Set **Current PIN**, **New PIN** and **Confirm New PIN**.
- Step 5** Click **Apply**.

PIN Management

PIN Status Enable
 Disable

Current PIN *

New PIN *

Confirm New PIN *

Attempts Left: 3

Apply

 **NOTE**

- A maximum of three consecutive failed attempts are allowed. If this limit is exceeded, you need to enter the PUK of the SIM card to unlock the SIM card.
- The device is disconnected from the internet during the change and you need to reconnect it manually.

---End

Appendix

A.1 FAQ

Q1. I cannot access the web UI of the device after entering 192.168.0.1. What should I do?

A1. Try the following methods:

- Verify that the IP address of your computer is **192.168.0.X (X: 2-253)**.
- Ensure no other devices with the IP address 192.168.0.1 exist in the local network.
- Clear the cache of your web browser or try with another web browser.
- Disable the firewall of your computer or try with another computer.
- If you have manually changed the LAN IP address of the device, change the IP address of your computer to another IP address that belongs to the same network segment as the new LAN IP address of the device and log in again using the new LAN IP address of the device.
- If the problem persists, restore the device to factory settings and try login again.

Q2. I cannot access the internet. What should I do?

A2. Try the following methods:

- Verify that your SIM card has sufficient balance.
- Ensure that the wireless network provided by the device is not blocked by environmental factors.
- Verify that your client is within the coverage of the device.
- Verify that your client connects to the device with the correct Wi-Fi name and password.
- Verify that you have enter the valid PIN (if required) of the device.
- Disable the firewall of your computer.
- Restart the device or restore the device to factory settings, and try again.

Q3. When the device is connected via the USB cable, the driver of this device is not installed automatically. What should I do?

A3. Try the following methods:

- Restart the device or your computer.
- Unplug the USB cable and plug it again.
- Access the folder of the driver, double-click the program corresponding to your operating system, and follow the onscreen instructions to install the driver.

A.2 Set the IP address of your computer (Example: Windows 7)

- Step 1** Choose **Start > Control Panel**, click **Network and Internet**, **Network and Sharing Center**, and **Change adapter settings** in sequence.
- Step 2** Right-click **Local Area Connection** and choose **Properties**. Select **Internet Protocol Version 4 (TCP/IPv4)** and click **Properties**.

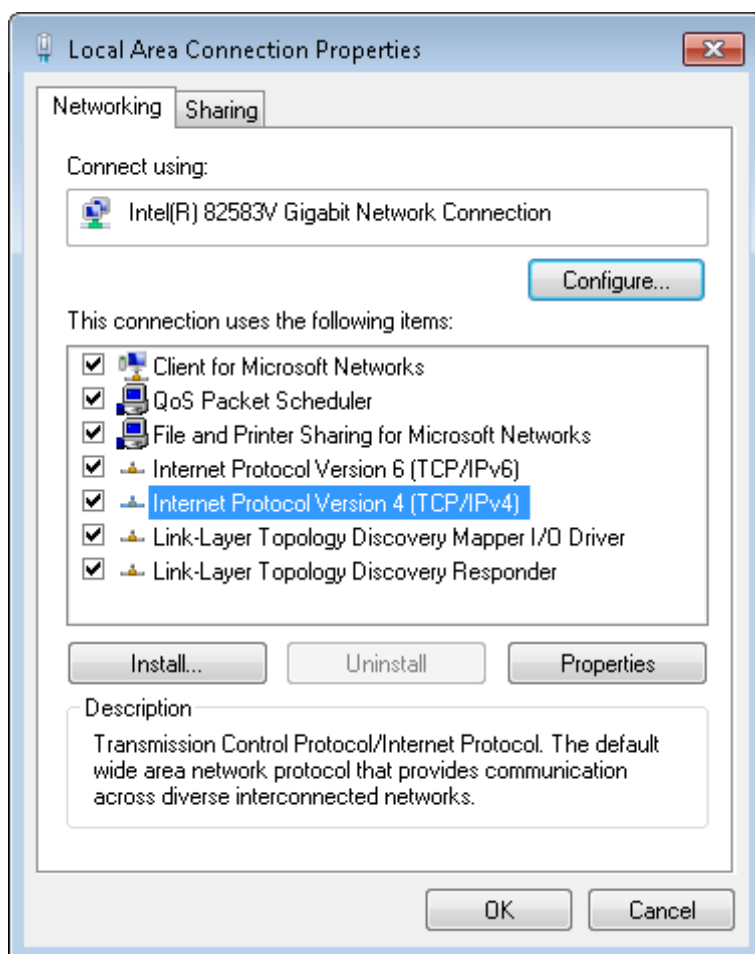

- Step 3** Select **Use the following IP address**. Set **IP address** to an IP address that is different from the IP address of the device but belongs to the same network segment as the IP address of the device. Set **Subnet mask** to **255.255.255.0**. Click **OK**.

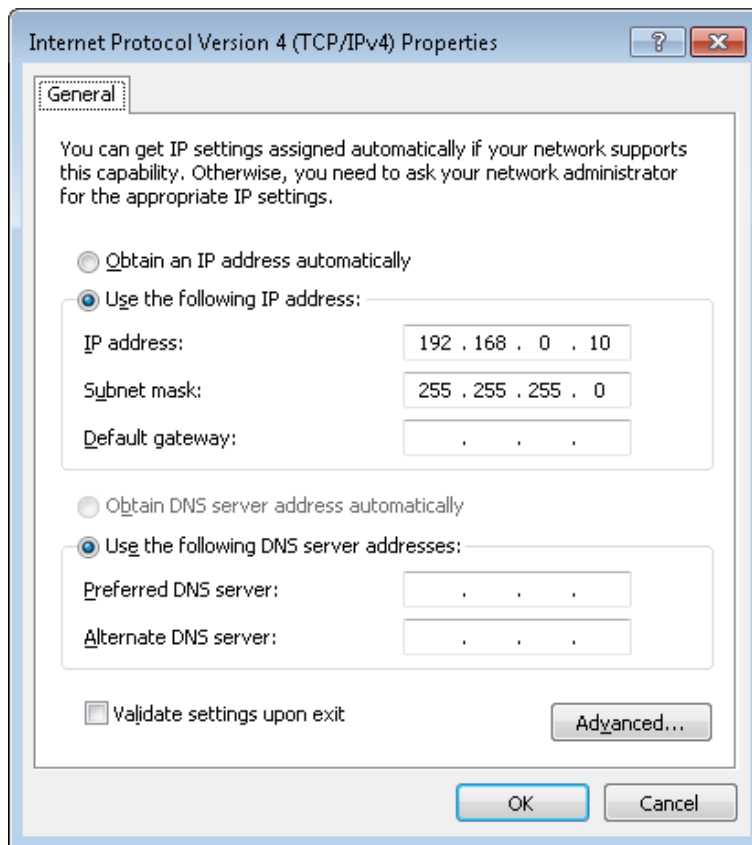

The **Local Area Connection Properties** dialog box appears.

Step 4 Click **OK**.

---End

A.3 Acronyms and Abbreviations

Acronym and Abbreviation	Full Spelling
AES	Advanced Encryption Standard
APN	Access Point Name
CHAP	Challenge Handshake Authentication Protocol
DHCP	Dynamic Host Configuration Protocol
DMZ	Demilitarized Zone
ID	Identity Document
IMEI	International Mobile Equipment Identity
IMSI	International Mobile Subscriber Identity
IP	Internet Protocol
IPv4	Internet Protocol Version 4
IPv6	Internet Protocol Version 6
ISP	Internet Service Provider
LAN	Local Area Network
LCD	Liquid Crystal Display
LED	Light Emitting Diode
LTE	Long Term Evolution
MAC	Medium Access Control
PAP	Password Authentication Protocol
PBC	Push Button Configuration
PC	Personal Computer
PCI	Physical Cell ID
PDP	Packet Data Protocol
PIN	Personal Identification Number

Acronym and Abbreviation	Full Spelling
PST	Pacific Standard Time
QR	Quick Response
RSRP	Reference Signal Received Power
RSRQ	Reference Signal Received Quality
RSSI	Received Signal Strength Indicator
SD	Secure Digital
SIM	Subscriber Identity Module
SINR	Signal to Interference plus Noise Ratio
SMS	Short Message Service
SNTP	Simple Network Protocol
SSID	Service Set Identifier
TCP	Transmission Control Protocol
UI	User Interface
UMTS	Universal Mobile Telecommunications System
USB	Universal Serial Bus
USSD	Unstructured Supplementary Service Data
WCDMA	Wideband Code Division Multiple Access
WPA	Wi-Fi Protected Access
WPA-PSK	WPA-Preshared Key
WPS	Wi-Fi Protected Setup
WWAN	Wireless Wide Area Network